

CE

 Bergstrom®

# INTEGRAL POWER



**Instrucciones de Montaje**

*Mounting Instructions*

**Instructions de Montage**

*Montageanweisungen*

**Istruzioni di Montaggio**

**ES** Spanish

**EN** English

**FR** French

**GE** German

**IT** Italian



F-4230 rev.00

1002606468

### Recomendaciones Para el montaje

- Antes de iniciar el montaje leer las instrucciones y seguirlas durante el proceso de instalación.
- Usar las herramientas adecuadas para cada operación.

### Electricidad

- Desconectar la llave de contacto.
- Desconectar la batería antes de empezar el montaje.
- Asegurar el conexionado de los componentes eléctricos, verificando su correcto encaje.

### Atención

Cualquier modificación de los sistemas ROPS / FOPS, como soldar o perforar agujeros en partes estructurales, afectará la capacidad de ROPS / FOPS para proporcionar la protección requerida. La instalación de este producto puede afectar los sistemas ROPS / FOPS.

Póngase en contacto con su distribuidor autorizado para verificar la compatibilidad antes de realizar modificaciones o reparaciones. De lo contrario, puede anular la certificación ROPS / FOPS. El fabricante del aire acondicionado de techo no asume responsabilidad alguna.

### Atención

Al instalar el equipo de aire acondicionado en el techo se debe proteger la parte superior de la cabina con un paño o manta protectora para evitar posibles arañazos. Al instalar **Integral Power II** en el techo hay que tener en cuenta que, normalmente, las cabinas que vienen provistas de escotilla, tienen una estructura suficiente para soportar el peso del equipo. Sin embargo, cuando no ocurra así y sea necesario realizar corte en el techo o incluso si en el caso de llevar escotilla el material no es lo suficientemente resistente (caso de techo de fibra, plástico, etc...) es el instalador el que debe decidir, bajo su responsabilidad, sobre la necesidad de reforzar el techo para evitar posibles deformaciones, roturas, entradas de agua, etc... habilitando los medios para que esto no ocurra.

### Herramientas

- Juego de Llaves Torx
- Juego de Llaves Allen
- Llave fija 10
- Tijeras
- Flexómetro
- Juego de carraca - boca Ø 10
- Destornillador estrella / plano
- Sierra circular Ø 35
- Taladro - boca Ø 7
- Sierra vaivén







### Documentación relacionada

Instrucciones de montaje	1002606468
Manual del usuario	1002606470
Diagnóstico de averías	1002606471
Listado de recambios	1002606469

### Documentación incluida

Garantía	220AA10010
----------	------------

### Advertencias

-  El personal instalador debe poseer una formación suficiente en Aire Acondicionado de vehículos.
-  **Bergstrom** queda exenta de responsabilidad si se producen averías que procedan de una inadecuada manipulación o instalación del equipo, o por modificaciones y sustituciones efectuadas sin nuestra expresa autorización por escrito.
-  Equipo precargado con gas refrigerante R-134a. **No manipular el circuito de gas refrigerante.**
-  Véase procedimiento de garantía del producto incluido en **Diagnóstico de Averías.**
-  Véase **Manual de Usuario** del equipo para el correcto funcionamiento del mando a distancia y del panel de control.
-  Al finalizar la instalación se debe entregar al usuario: **Manual del Usuario, Garantía y Diagnóstico de averías.**

**1** Posicionar el equipo **Integral Power II** sobre el techo, teniendo en cuenta que la posición final debe corresponder con el frente suministrado procurando que quede sobre superficie plana.

**2** Una vez definida la posición, quitar la carcasa y marcar (6) taladros (Y) seguidamente hacer coincidir los (4) taladros de la plantilla con (4) taladros traseros del techo (figura 3).  
**Tener en cuenta la flecha que indica el sentido de la marcha.**

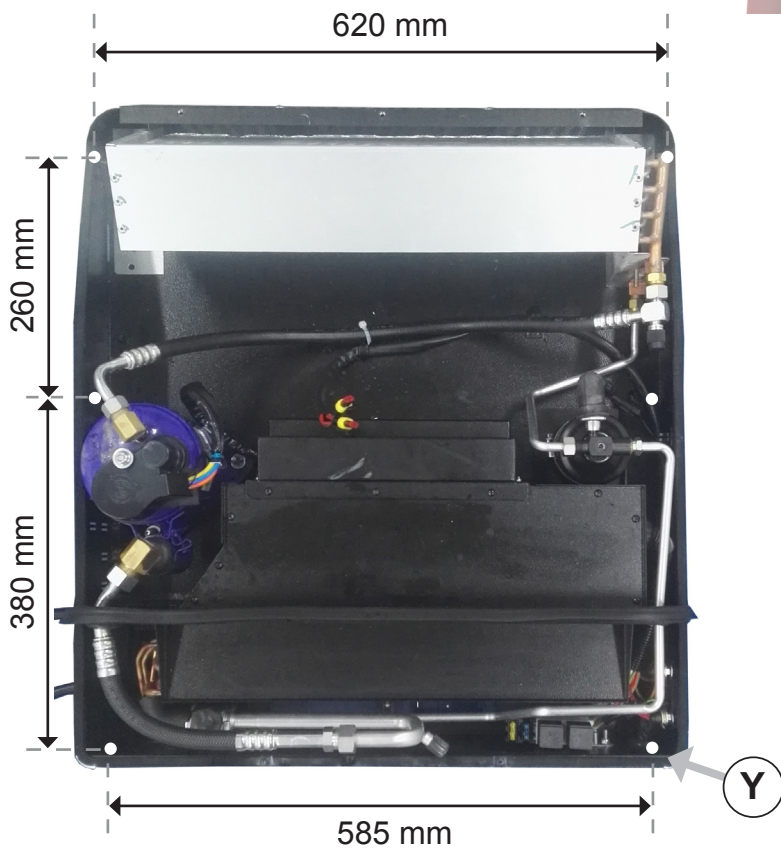
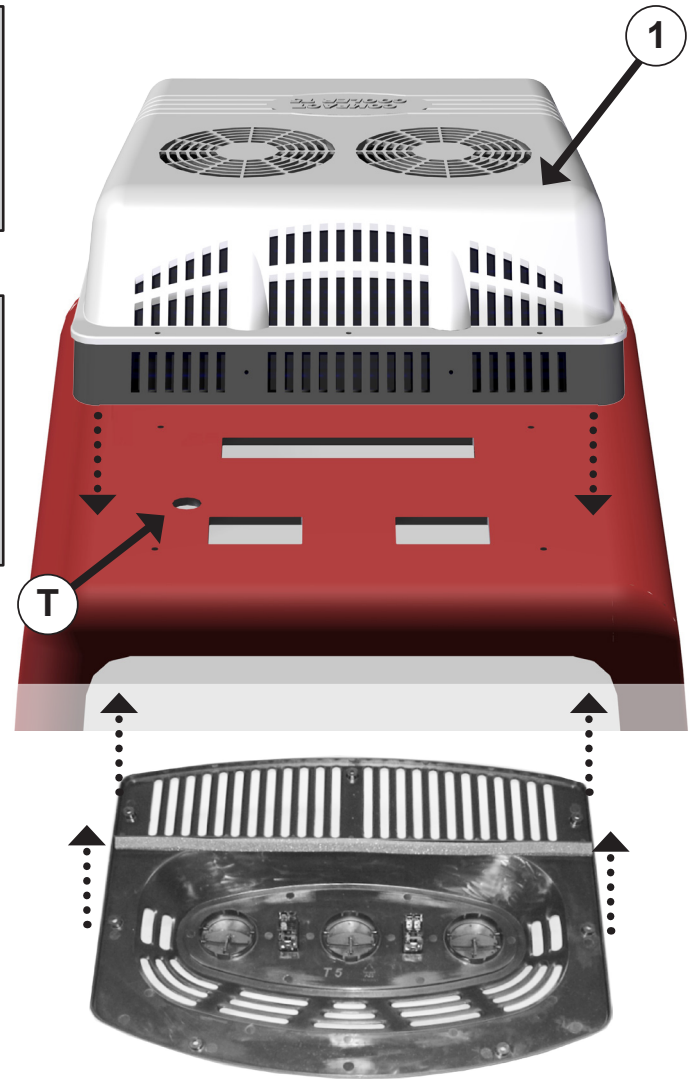

**3** Marcar los cortes y taladros y proceder a realizarlos (proteger los cantos cortados con antioxidante).

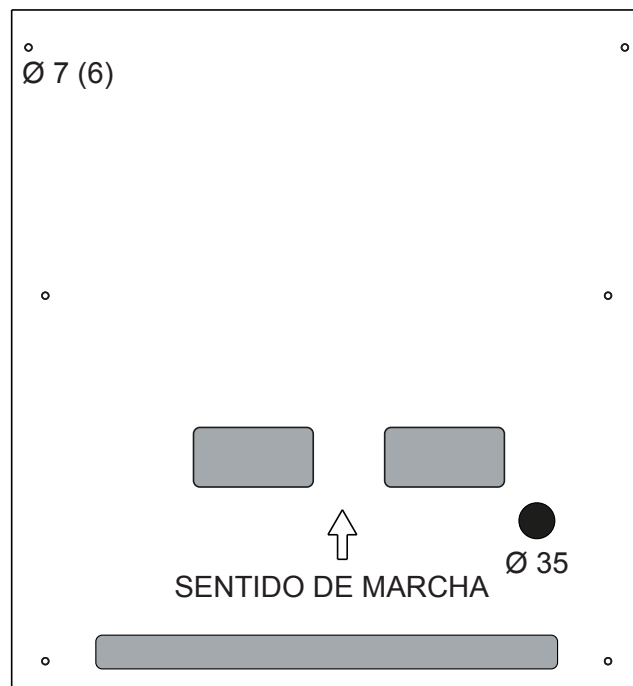

**4** Colocar junta cierre, juntas laterales y junta frontal en la parte interior del compacto como se muestra.

<b>a</b>	Junta cierre
<b>b</b>	Juntas laterales
<b>c</b>	Junta frontal

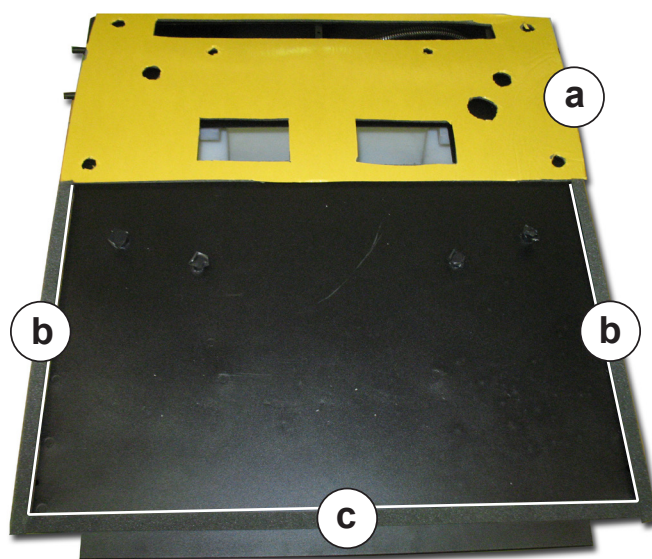

**5** Pasar cableado por el traladro (T) realizado en el techo para ello (figura 1). Colocar Integral Power (A) con (6) casquillos de 13 mm, arandelas de goma y (6) tornillos M6/100x40 (B) y tuercas M6/100.

 **Importante:** Asegurar estanqueidad del conjunto al techo para impedir posibles entradas de agua.

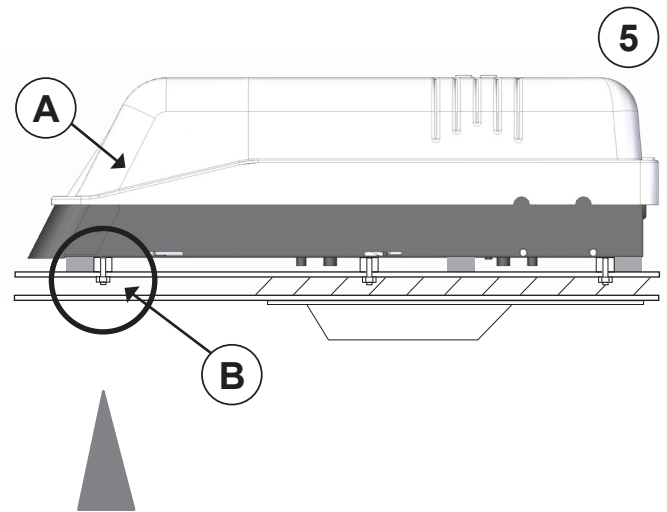

**6A** Colocar arandelas de goma para evitar paso de agua.

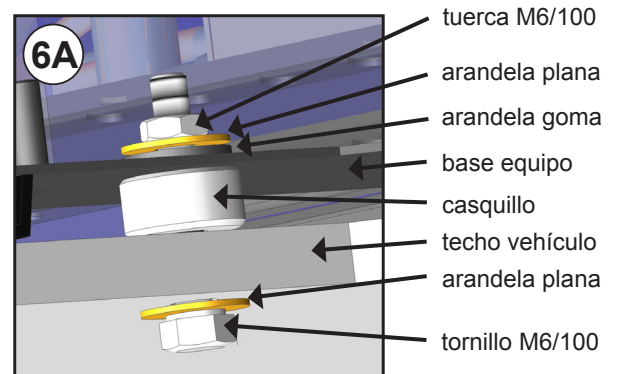

6B

Colocar tubos PVC Ø 9 x Ø 13 suministrados en el equipo según necesidad de longitud.



**Atención:** Colocar válvulas de drenaje al final de los tubos de PVC para facilitar el drenaje de agua.

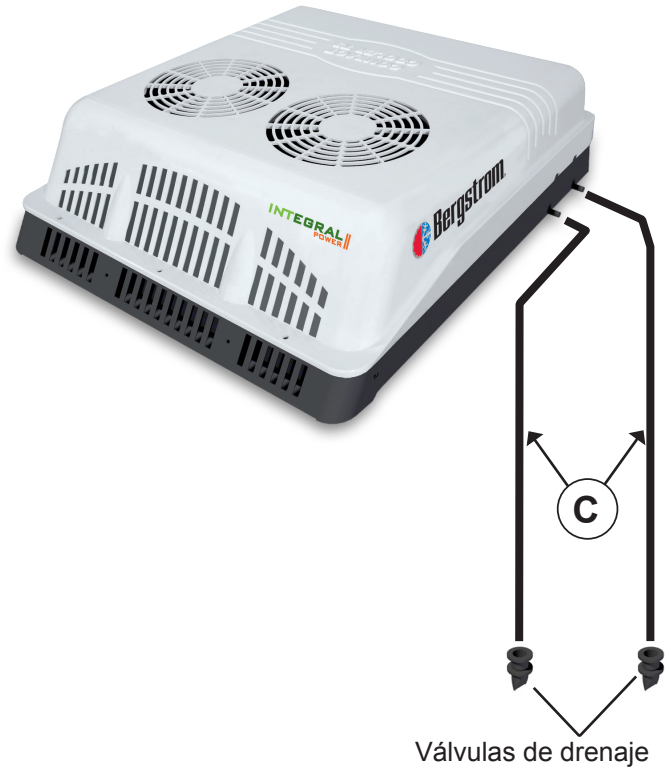

### Cableado de conexión a alternador o bajo llave de contacto para funcionamiento del equipo con motor en marcha



**Atención:** El cableado se instalará en todos los vehículos para que el equipo funcione a motor arrancado.

7

Colocar cableado de excitación por el interior o por el exterior del vehículo según convenga y montar frente con tornillos roscachapa suministrados. Conectar interruptores como se indica.

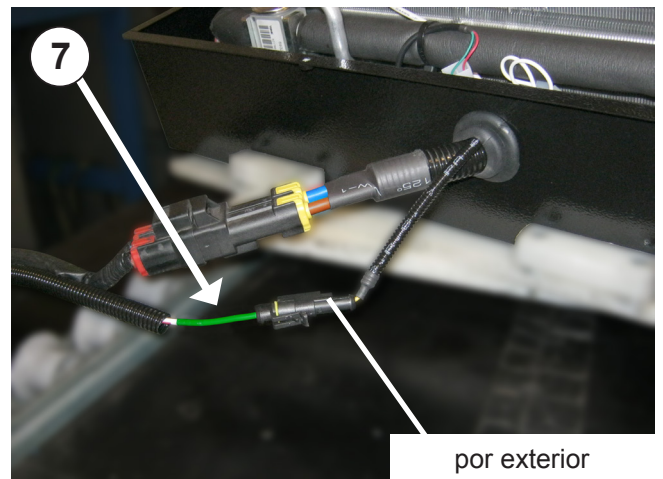

Interruptor velocidades aire

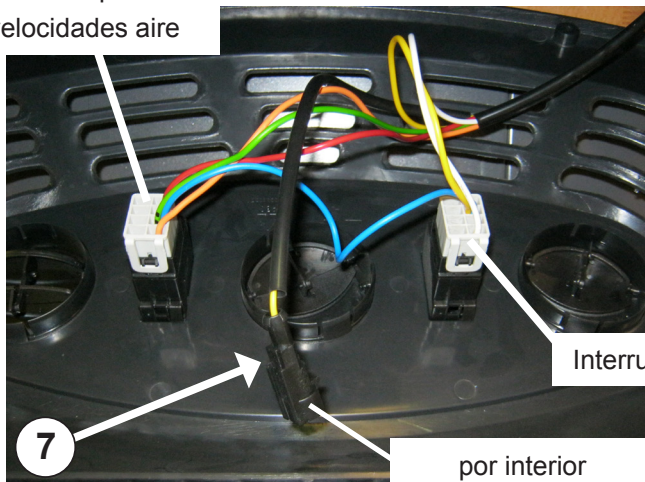

Interruptor A/A

por interior

**8** Conectar el otro extremo del cableado suministrado en posición (+) sólo con motor arrancado o a través de (+) llave de contacto.

**9** Conectar cable de alimentación superior en la parte trasera del equipo.

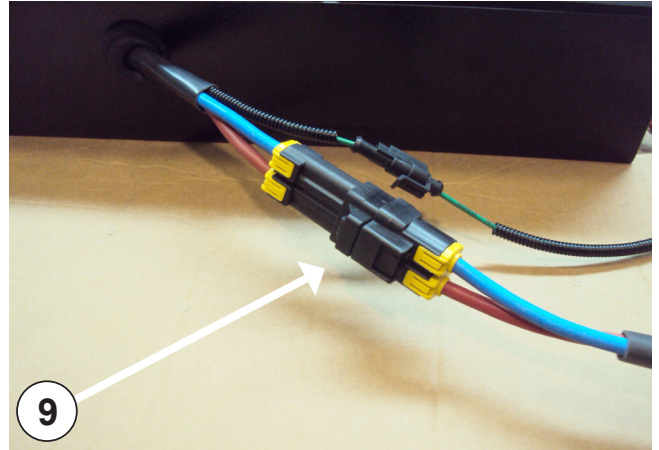

**10** Conectar cable de alimentación inferior (A) llevándolo a batería y poner adhesivos de peligro de unión de cableado en lugar visible (B).

 **Importante:** Al conectar los cableados, dejar la distancia adecuada, para evitar su rotura por los movimientos del vehículo.

 **Importante:** Para la puesta en marcha consultar el manual de usuario (1002185994).

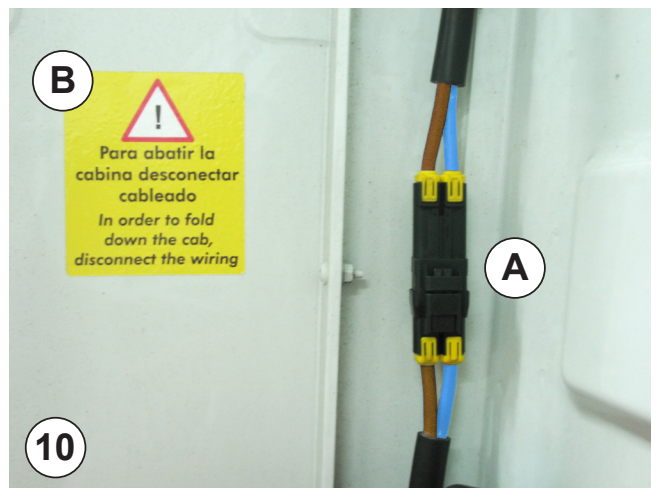

Esquema eléctrico

Az	Azul
N	Negro
R	Rojo
V	Verde
B	Blanco
A	Amarillo
Na	Naranja
M	Marrón

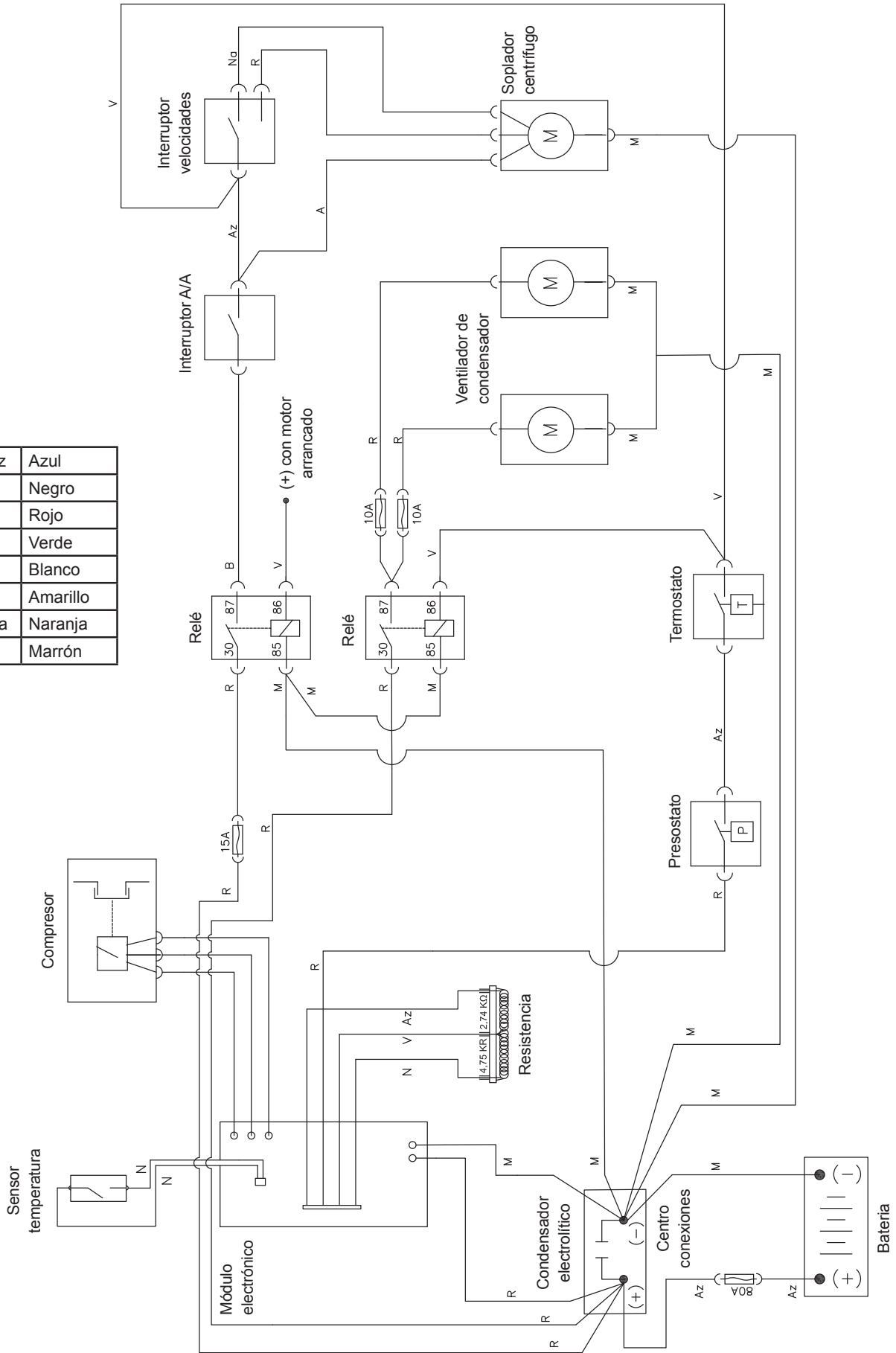



A series of horizontal dotted lines spanning the width of the page, providing a template for writing or drawing.

### Assembly Recommendations

- Before starting assembly, please read instructions and follow them during installation process.
- Use the adequate tools for each operation.

### Electricity

- Disconnect ignition key.
- Disconnect battery before starting assembly.
- Make sure electric components are securely connected, checking their correct fitting.

### Warning

Any modification to ROPS/FOPS, such as welding or drilling holes in the structural members for mounting brackets, will affect the ROPS/FOPS capability to provide the required protection. Installing this product may affect ROPS/FOPS systems.

Contact your authorized dealer to check compatibility before making any modifications or repairs. Failure to do so may void the ROPS/FOPS certification. The manufacturer of the roof air conditioner assumes no liability whatsoever.

### Warning

When installing air conditioning equipment on roof, the upper cabin part must be protected with a cloth or a protective blanket to avoid possible scratches. When installing **Integral Power II** on roof, take into account that, normally, cabins equipped with a hatch have a strong enough structure to hold equipment weight. However, if it is not the case and it is necessary to carry out a cut in the roof or, although it has a hatch, the material is not resistant enough (*if roof is made of fibre, plastic, etc...*), it is the installer who will have to decide, under his responsibility, if it is necessary to reinforce the roof to avoid possible deformations, breaks, water entries, etc., habilitating the means required to stop it from occurring.

### Tools

- Set of Torx keys
- Set of Allen keys
- Ø10 Spanner
- Scissors
- Flexometer
- Ø10 Wrench
- Phillips screwdriver / screwdriver
- Ø35 Circular saw
- Ø7 Drill
- Sabre saw







### Related documentation

Mounting instructions	1002606468
User's guide	1002606470
Troubleshooting	1002606471
Parts list	1002606469

### Documentation included

Warranty	220AA10010
----------	------------

### Warnings

-  The installing personnel must have a sufficient training in vehicles air conditioning.
-  **Bergstrom** shall not be responsible for breakdowns or damages coming from an inadequate handling or installation of the equipment or from modifications and substitutions carried out without our express and written authorisation.
-  Unit pre-loaded with refrigerant gas R-134a. **Do not touch the refrigerant gas circuit.**
-  Please see product warranty procedure included in **Troubleshooting**.
-  Please see equipment **User's Guide** for its correct functioning of the remote control and control panel.
-  Once installation is finished, the following documents must be handed over to the user: **User's Guide, Warranty** and **Troubleshooting**.

**1** Position the **Integral Power II** unit on the roof, taking into account that the final position must correspond to the front supplied, ensuring it is on a flat surface.

**2** Once the position is defined, remove the case and mark (6) boreholes (**Y**), then align the (4) template boreholes with the (4) rear boreholes in the roof (figure 3).  
**Note the arrow indicating the operation direction.**

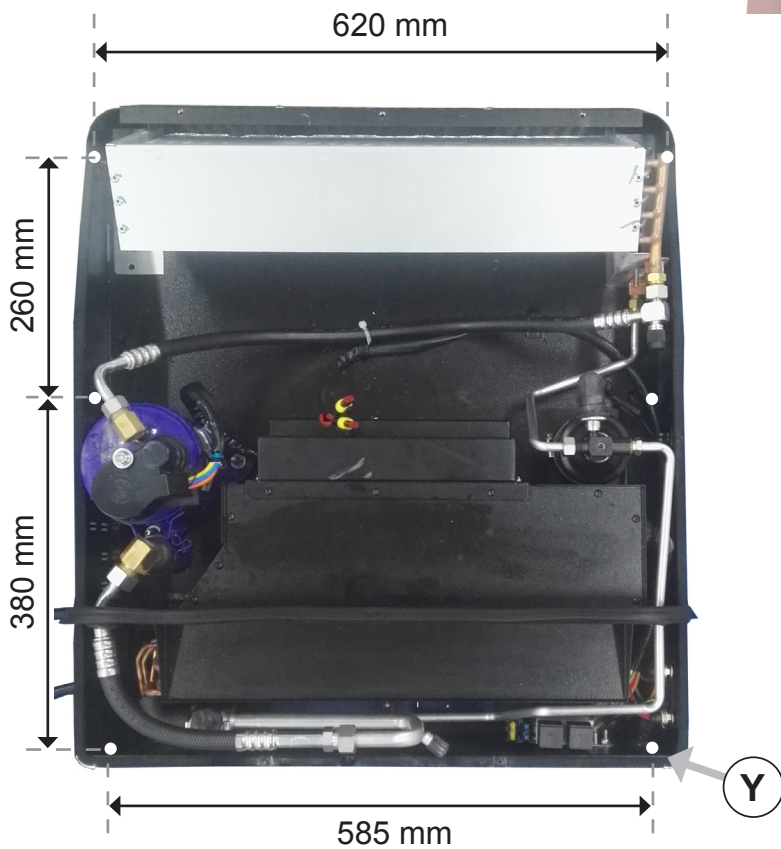
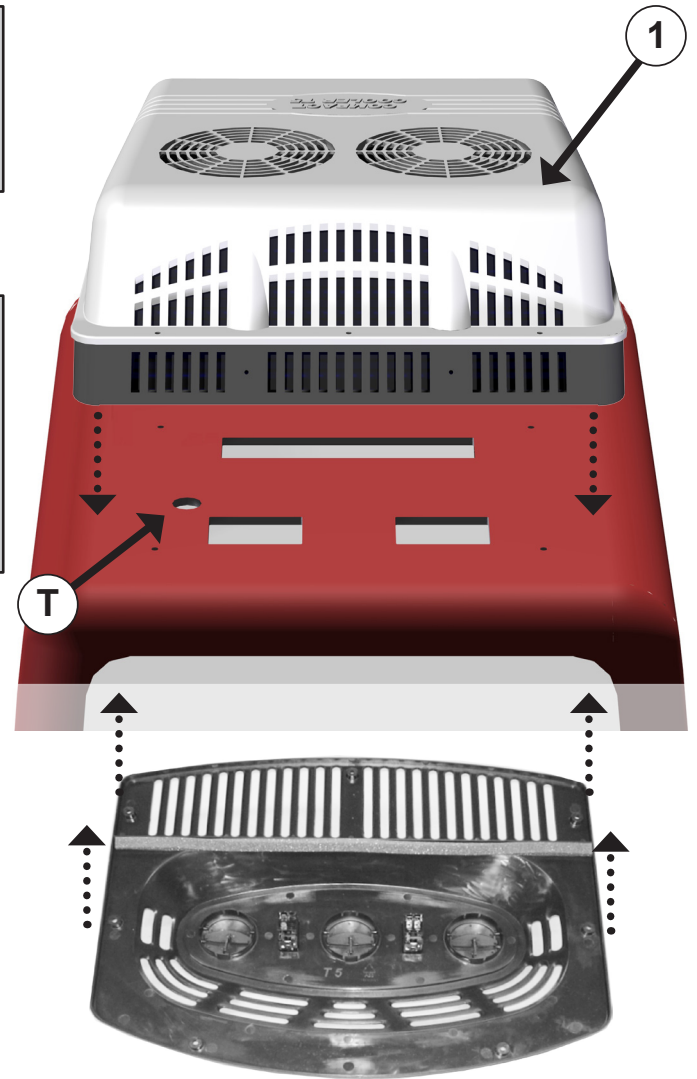

**3** Mark and make the cuts and boreholes (protect the sharp edges with anti-oxidant).

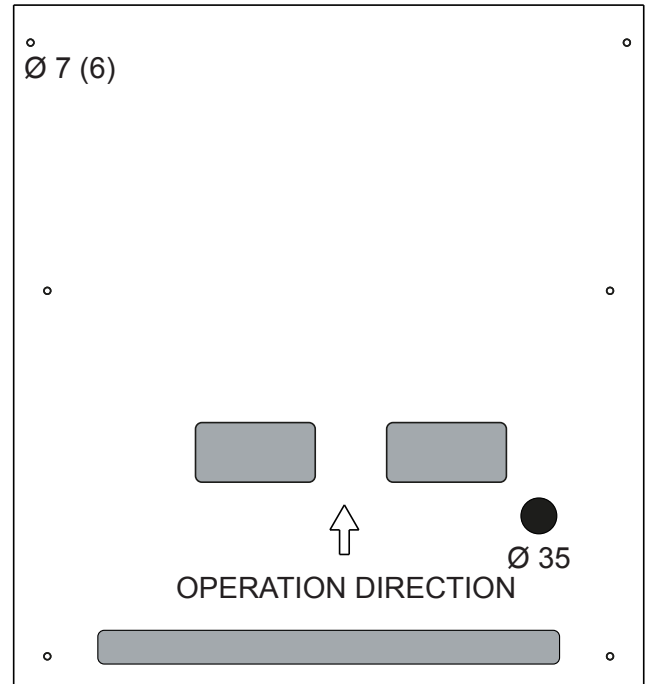

**4** Position the seal joint, side seals and front seal inside the compact as shown.

<b>a</b>	Seal joint
<b>b</b>	Side seals
<b>c</b>	Front seal

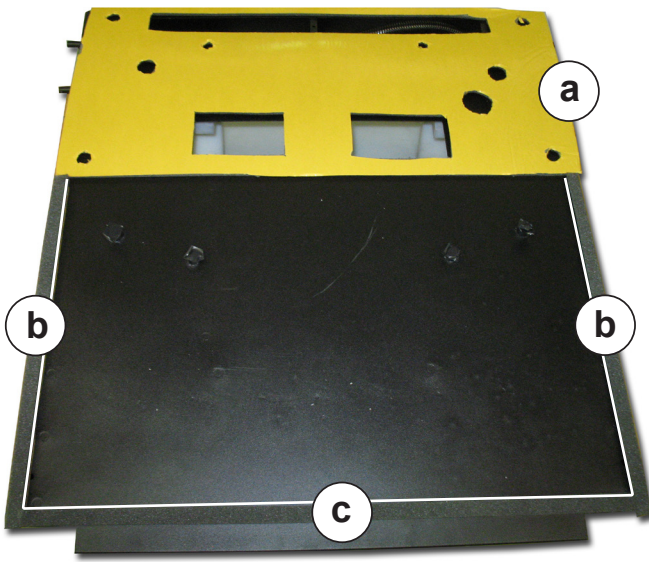

**5** Pass the cabling through the borehole (T) made for this purpose in the roof (figure 1). Position Integral Power (A) with (6) 13 mm pieces of bushing, rubber washers and (6) M6/100x40 screws (B) and nuts M6/100.

 **Important:** Ensure sealtightness between the unit and the ceiling in order to prevent any water coming in.

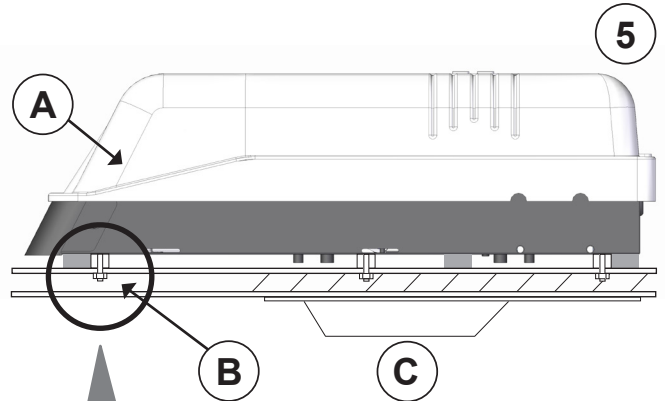

**6A** Insert rubber washers to prevent water passage.

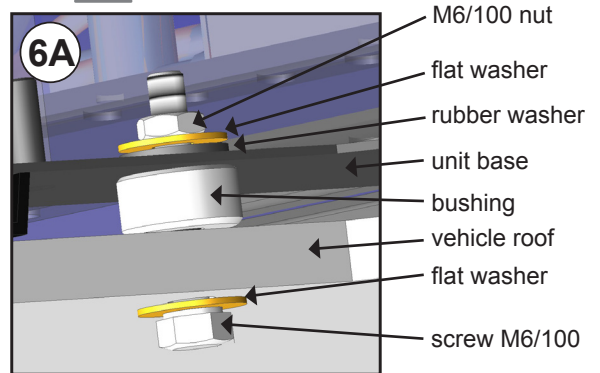

**6B** Position Ø9 x Ø13 PVC pipes, as supplied, in the unit in accordance with required length.

 **Caution:** Position drainage valves at the end of the PVC pipes for the water to run off.

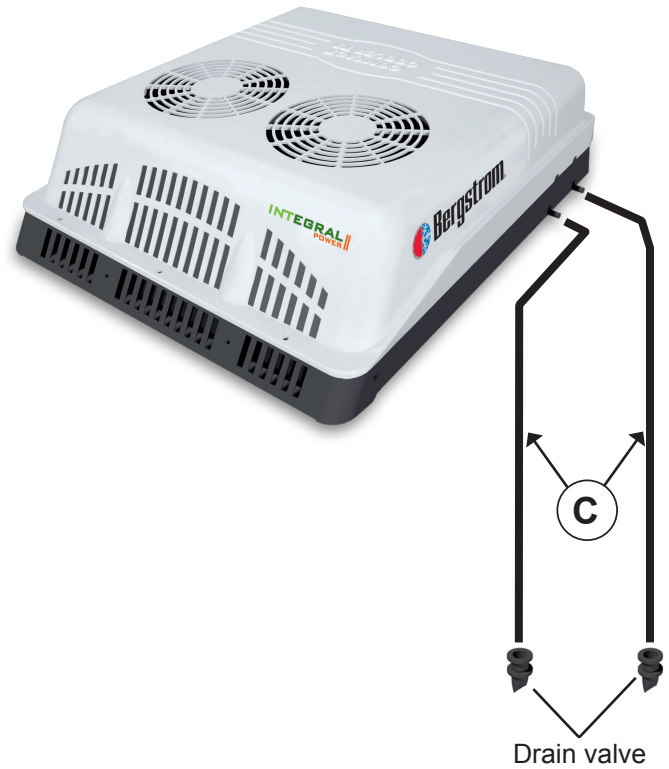

**Connection to alternator cable for unit operation with the engine running**

 **Caution:** The cable will be installed in all vehicles for the unit to work with the engine started up.

**7** Position excitation cable on the inside or outside of the vehicle as appropriate, and secure the front with the supplied self-tapping screws. Connect switches as shown.

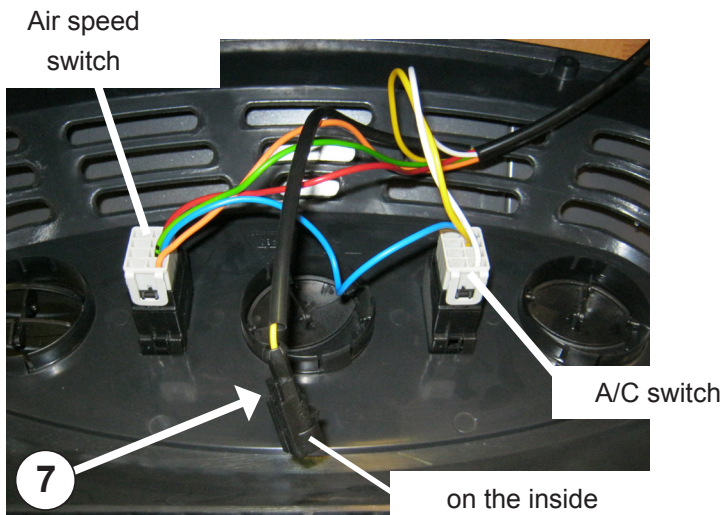
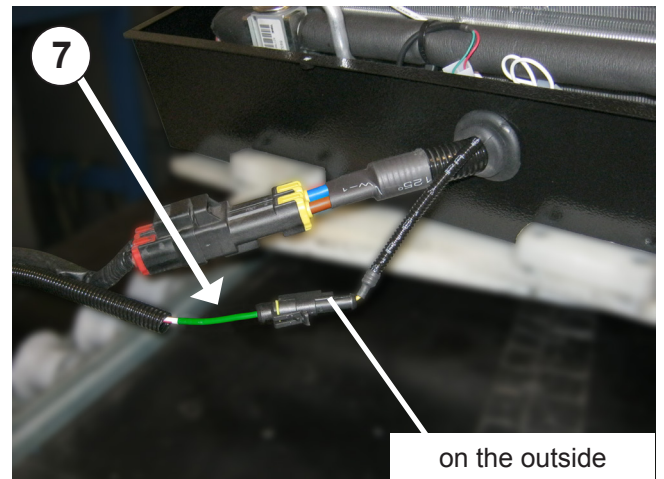

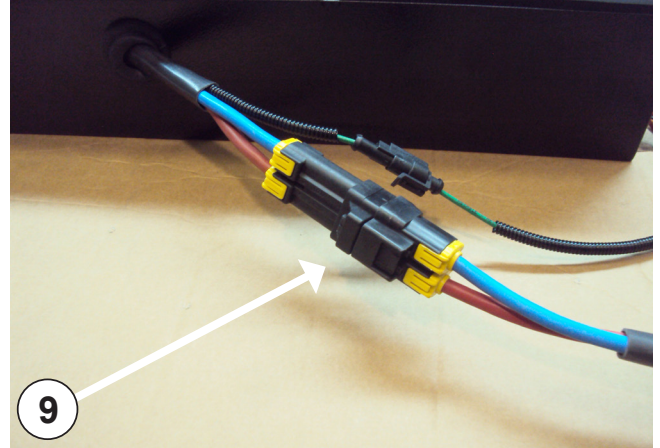

**8** Connect the other end of the supplied cable in position (+) only with the engine started up or through the (+) ignition key.

**9** Connect the upper power cable in the rear of the unit.



**10** Connect the lower power cable (A) to the battery and place cable joint hazard stickers in a visible place (B).

 **Important:** When connecting the cables, leave suitable distance in order to prevent breakage when the vehicle moves.

 **Important:** Check the user manual (1002185994) before starting up.

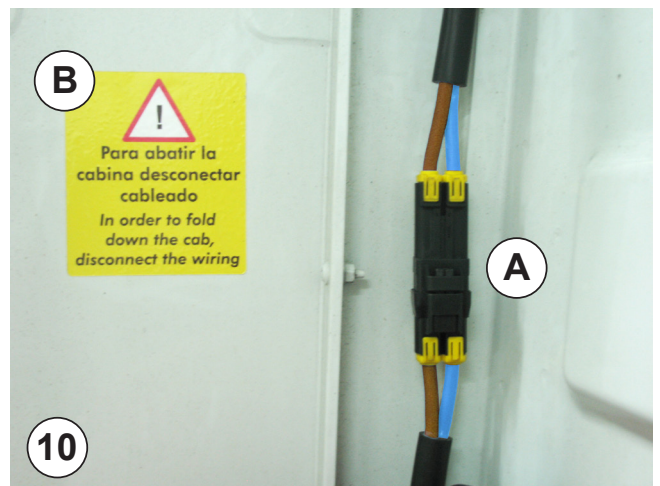

Az	Blue
N	Black
R	Red
V	Green
B	White
A	Yellow
Na	Orange
M	Brown

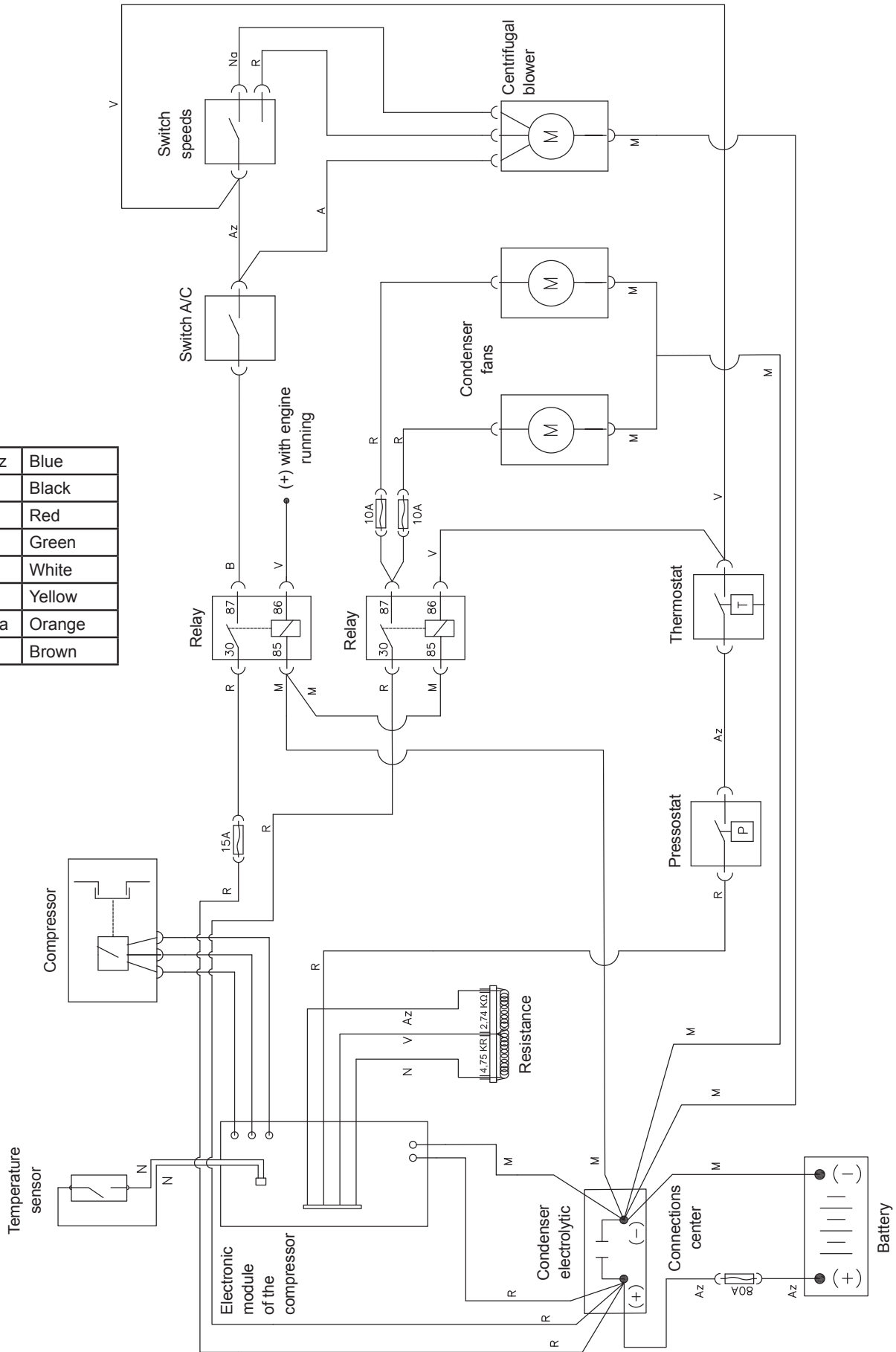





## Recommandations Pour le montage

- Avant de commencer le montage de l'appareil, prière de lire les instructions et de les suivre attentivement.
- Utiliser les outils convenant à chaque opération.

## Electricity

- Déconnecter la clé de contact.
- Déconnecter la batterie avant de commencer le montage.
- Vérifier le câblage des composants électriques et leur correcte installation.

### Attention

Toute modification des systèmes ROPS / FOPS, comme le soudage ou le perçage de trous dans des pièces structurales, affectera la capacité de ROPS / FOPS à fournir la protection requise. L'installation de ce produit peut affecter les systèmes ROPS / FOPS.

Contactez votre distributeur agréé pour vérifier la compatibilité avant d'effectuer des modifications ou des réparations; dans le cas contraire, vous pouvez annuler la certification ROPS / FOPS. Le fabricant du système de climatisation de toit n'assume aucune responsabilité.

### Attention

Lors de l'installation de l'appareil d'air conditionné sur le toit, il faudra protéger la partie supérieure de la cabine avec un linge ou une couverture de protection afin d'éviter les éventuelles égratignures.

Durant l'installation du **Integral Power II**, tenir compte du fait que normalement les cabines pourvues d'écoutille possède une structure suffisamment solide pour supporter le poids de l'appareil. Cependant, si ce n'est pas le cas et qu'il est nécessaire de découper le toit ou même si disposant d'écoutille, la structure n'est pas suffisamment rigide (si elle était en fibre, plastique, etc.) il appartiendra à l'installateur de décider s'il faut renforcer le toit pour éviter toute déformation, rupture ou voie d'eau, etc., et prendre les mesures nécessaires à cet effet.

## Outils

Jeu de Clés Torx  
 Jeu de Clés Allen  
 Clé fixe 10  
 Ciseaux  
 Flexomètre  
 Jeu de clés à cliquet - mèche Ø 10  
 Tournevis étoile / tournevis  
 Scie circulaire Ø 35  
 Perceuse - mèche Ø 7  
 Scie sauteuse







## Documents rattachés

Instructions de Montage	1002606468
User's guide	1002606470
Diagnostic de problèmes	1002606471
Liste de rechanges	1002606469

## Documentation incluse

Garantie	220AA10010
----------	------------

### Attention

-  L'installateur devra posséder la formation pertinente en air conditionné sur véhicules.
-  **Bergstrom** ne sera pas responsable des dommages ou des bris dérivés d'une installation ou d'une manipulation incorrecte ni des modifications réalisées sans autorisation expresse par écrit.
-  Équipement préchargé avec gaz réfrigérant R-134a.  
**Ne pas manipuler le circuit de gaz réfrigérant.**
-  Voir la procédure de garantie du produit au Diagnostic de problèmes.
-  Voir le **Guide de l'Usager** de l'appareil pour le fonctionnement correcte de la télécommande et du tableau de commande.
-  Les documents suivants devront être remis à l'utilisateur une fois l'installation terminée: **Guide de l'Usager**, **Garantie** et **Diagnostic de problèmes**.

**1** Situer l'équipement **Integral Power II** sur le plafond. La position finale doit correspondre à la partie frontale fournie. Il doit être placé sur une surface plate.

**2** Une fois que la position est définie, retirer la carcasse et marquer (6) trous (Y) et faire ensuite coïncider les (4) trous du patron avec les (4) trous arrière du plafond (figure 3).  
**Tenir compte de la flèche qui indique le sens de la course.**

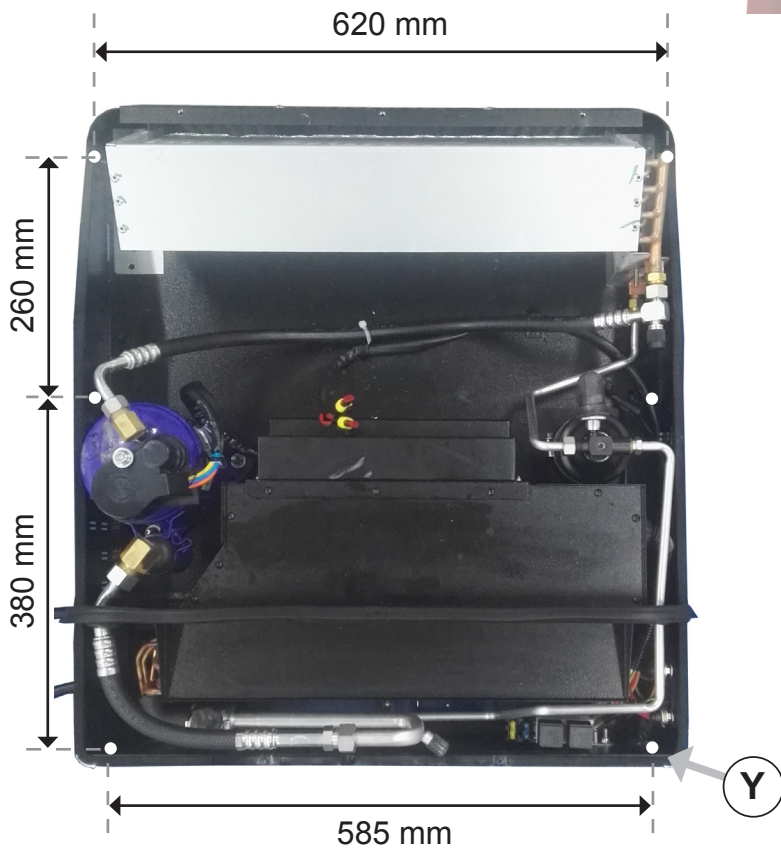
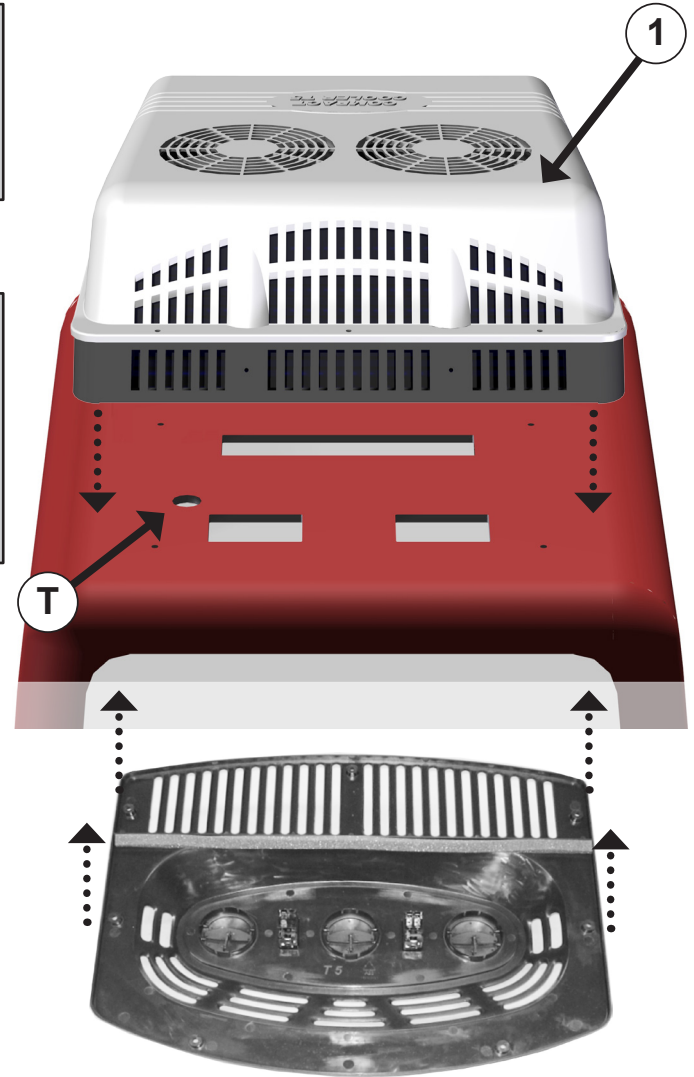

**3** Marquer les coupes et les trous et les réaliser (protéger les bords coupés avec de l'antioxydant).

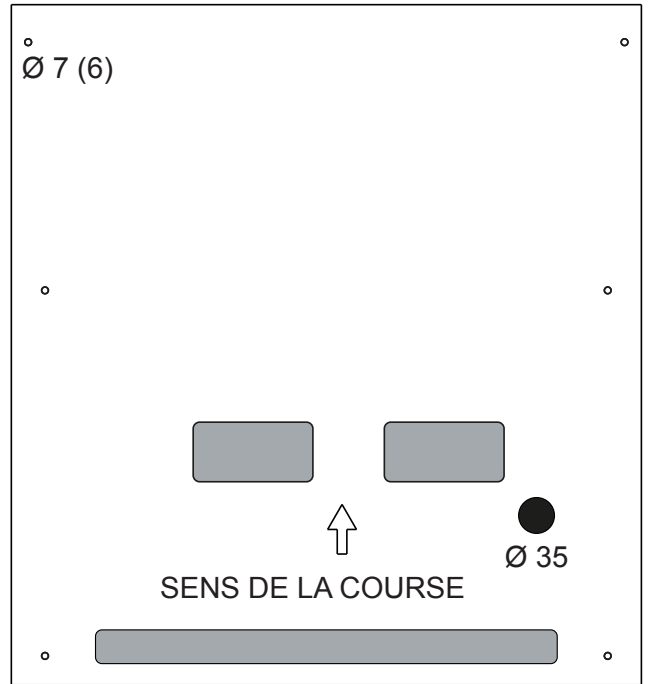

**4** Placer le joint d'étanchéité, les joints latéraux et le joint frontal sur la partie intérieure du Integral Power comme cela est indiqué.

<b>a</b>	Joint étanchéité
<b>b</b>	Joints latéraux
<b>c</b>	Joint frontal

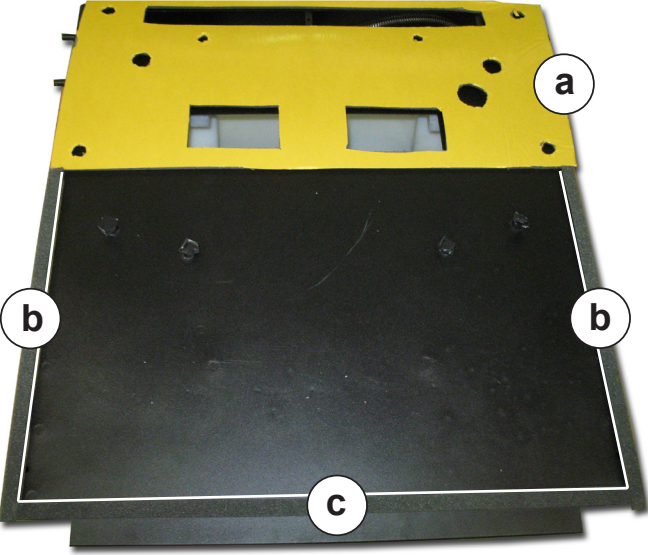

**5** Passer le câblage à travers le trou (T) réalisé sur le plafond à cet effet (figure 1). Placer ensuite l'Integral Power (A) avec (6) douilles de 13 mm, des rondelles en caoutchouc et (6) vis M6/100x40 (B) et écrous M6/100.

**Important** : assurer l'étanchéité de l'ensemble sur le plafond pour éviter de possibles entrées d'eau.

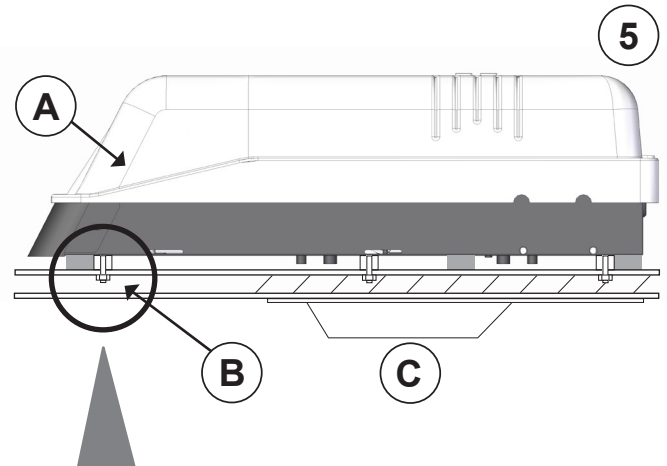

**6A** Placer les rondelles en caoutchouc pour éviter le passage de l'eau.

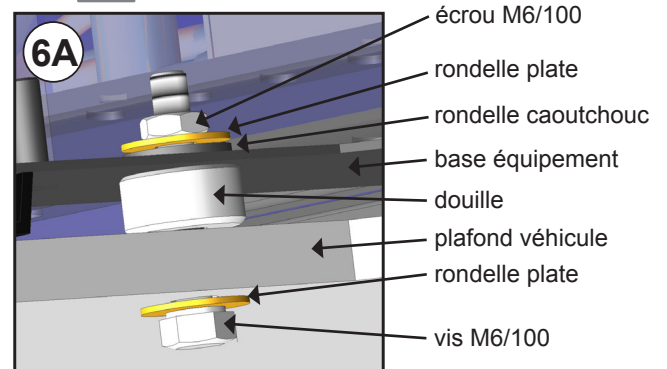

**6B** Placer les tuyaux en PVC Ø 9 x Ø 13 fournis dans l'équipement selon le besoin de longueur.



**Attention:** placer les vannes de drainage à la fin des tuyaux en PVC pour faciliter le drainage de l'eau.

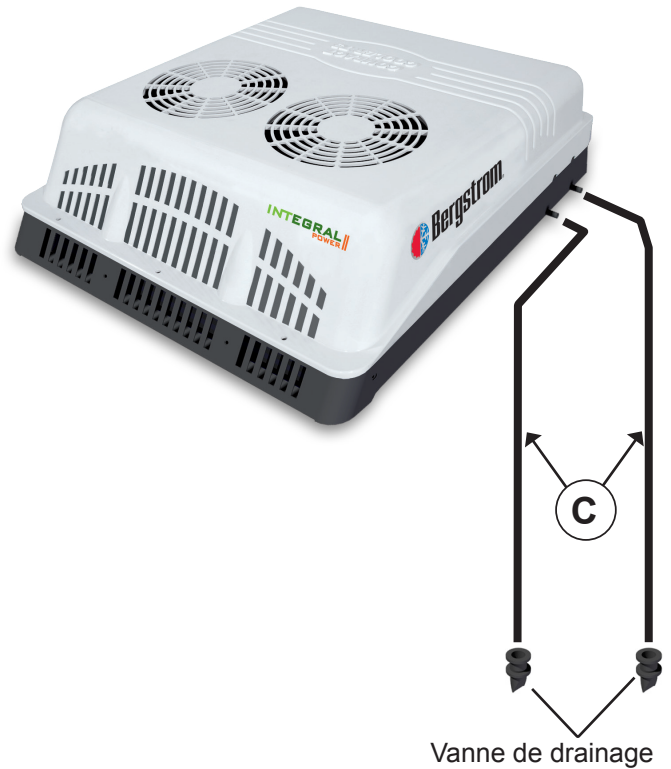

### Câblage de connexion à alternateur pour fonctionnement équipement avec moteur en marche



**Attention:** le câblage sera installé dans tous les véhicules pour que l'équipement fonctionne avec le moteur démarré.

**7** Placer le câblage d'excitation à l'intérieur ou à l'extérieur du véhicule et monter avec les vis taraudeuses fournies. Connecter les interrupteurs comme cela est indiqué.

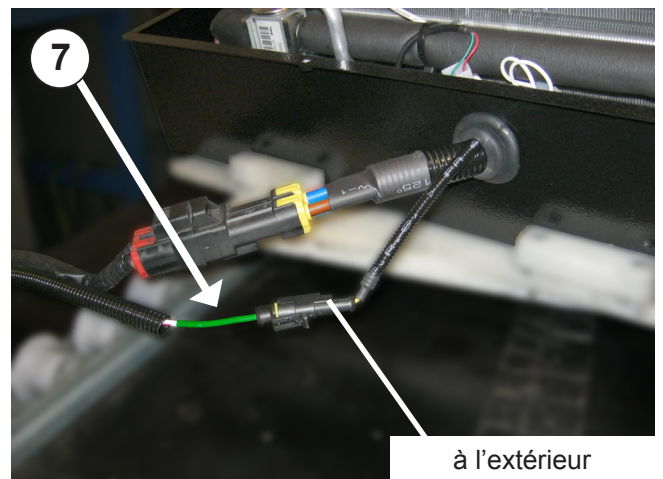

Interrupteur vitesses air

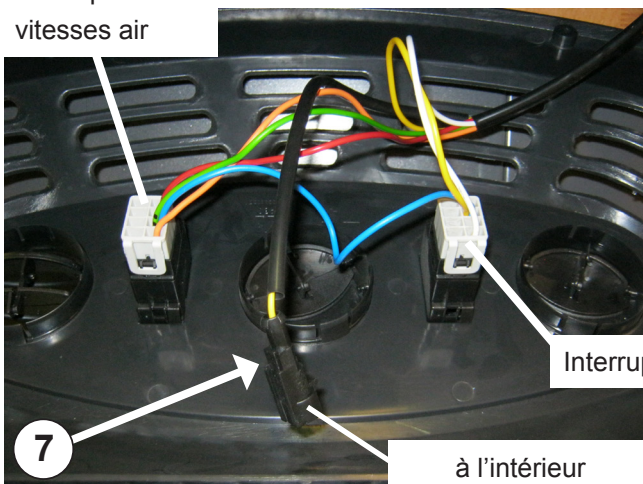

Interrupteur A/A

à l'intérieur

**8** Connecter l'autre extrémité du câblage fourni sur la position (+) uniquement avec le moteur démarré ou à travers (+) clé de contact.

**9** Connecter le câble d'alimentation supérieur à la partie arrière de l'équipement.

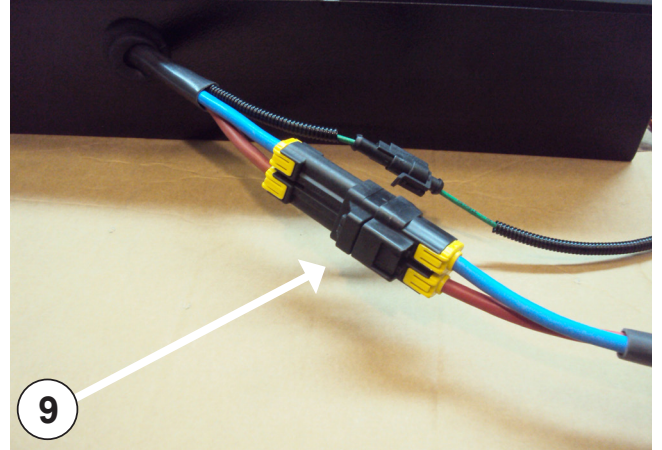

**10** Connecter le câble d'alimentation inférieur (A) en le menant à la batterie et placer des adhésifs de danger d'union de câblage sur un lieu visible (B).

 **Important:** Au moment de connecter les câblages, prévoir une distance suffisante pour éviter leur rupture à cause des mouvements du véhicule.

 **Important :** Pour la mise en marche, consultez le manuel de l'utilisateur (1002185994).

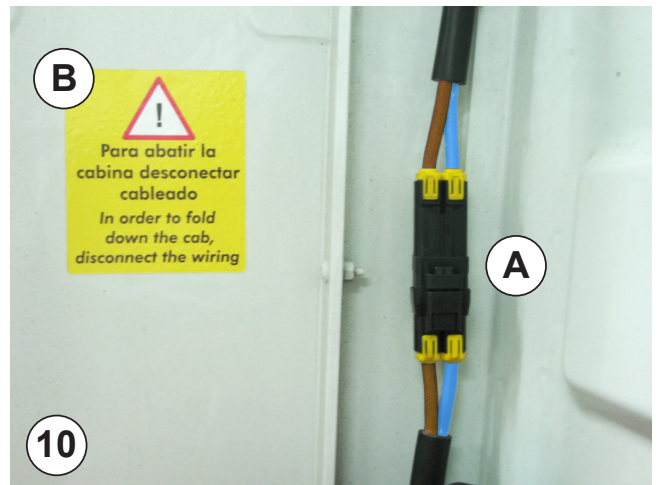

Câblage électrique

Az	Bleu
N	Noir
R	Rouge
V	Vert
B	Blanc
A	Jaune
Na	Orange
M	Marron

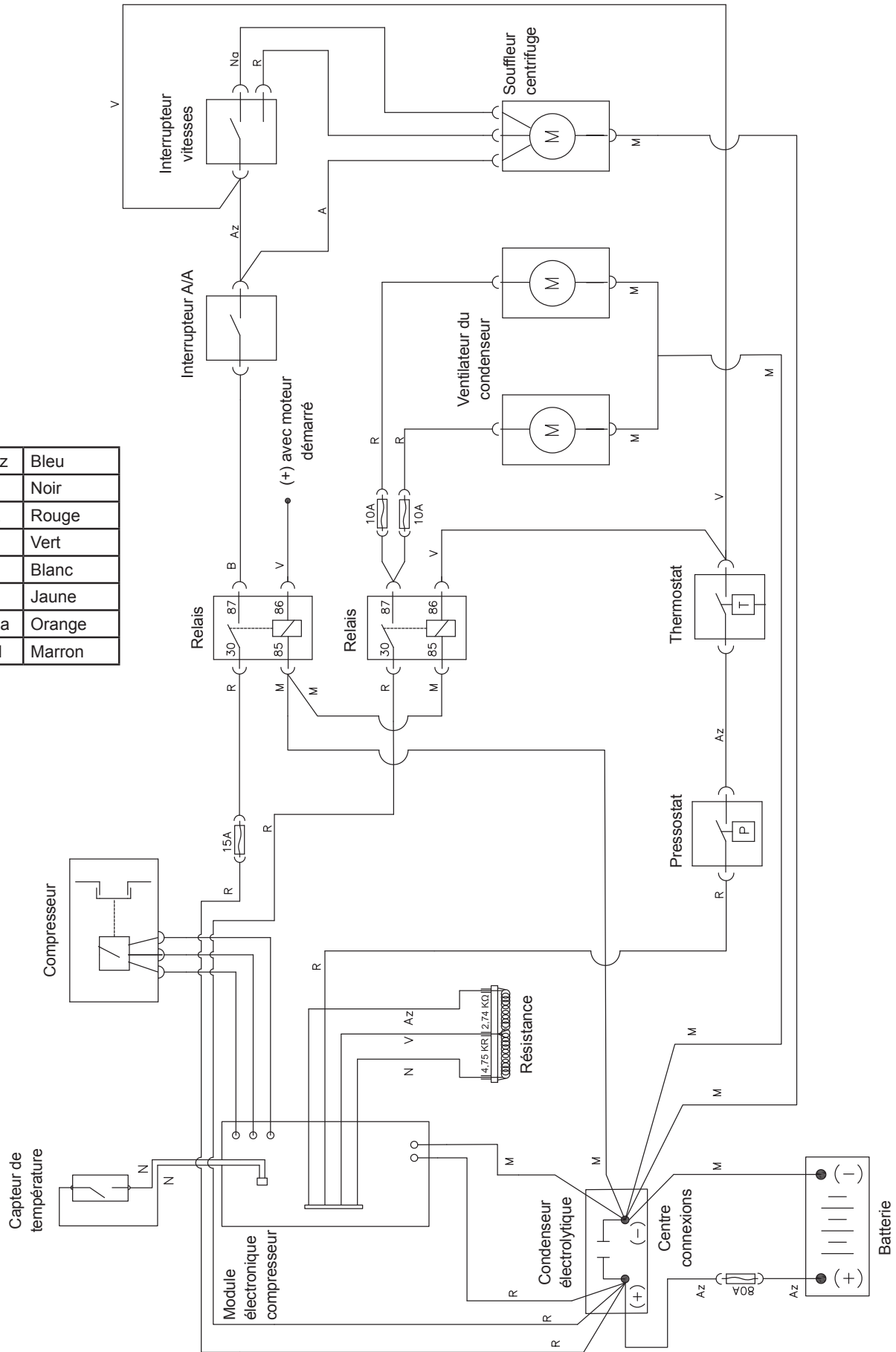



.....

.....

.....

.....

.....

.....

.....

.....

.....

.....

.....

.....

.....

.....

.....

.....

.....

.....

.....

.....

.....

.....

.....

.....

.....

.....

.....

### Empfehlungen Zur montage

- Vor und während der Montage bitte diese Anweisungen lesen und beachten.
- Benutzen Sie für jeden Arbeitsschritt die geeigneten Werkzeuge.

### Elektrizität

- Zündschlüssel ziehen.
- Vor Montagebeginn Batterie abklemmen.
- Ordnungsgemäßen Anschluss und korrekte Installation der Elektrokomponenten überprüfen.

### Warnhinweise

Jegliche Modifikation bezüglich ROPS/FOPS, wie zum Beispiel das Schweißen oder das Bohren von Löchern in tragenden Teilen, beeinflusst die ROPS/FOPS-Kapazität, den gewünschten Schutz bereitzustellen. Die Installation dieses Produktes kann sich auf die ROPS/FOPS-Systeme auswirken.

Wenden Sie sich an Ihren autorisierten Händler, um die Kompatibilität zu überprüfen, bevor Sie irgendwelche Modifikationen oder Reparaturen durchführen. Andernfalls kann die ROPS/FOPS-Zertifizierung ungültig werden. Der Hersteller der Dach-Klimaanlage übernimmt keinerlei Haftung.

### Vorsicht

Wird die Klimaanlage im Kabinendach installiert, muss der obere Teil der Kabine mit einem Tuch oder einer Decke gegen eventuelle Kratzer geschützt werden. Bei der Installation des **Integral Power II** im Kabinendach muss darauf geachtet werden, dass mit Luke ausgestattete Kabinen eine über eine ausreichend stabile Struktur verfügen, um dem Gewicht des Geräts Stand zu halten. Sollte das Fahrzeug über keine Luke verfügen und es notwendig sein, das Kabinendach aufzuschneiden, bzw. sollte die vorhandene Struktur nicht ausreichend stabil sein (z.B. wenn sie aus Faser, Kunststoff usw. hergestellt ist), obliegt es dem Installateur zu entscheiden, ob das Kabinendach zur Vermeidung von Verformungen, Brüchen, undichten Stellen usw. verstärkt werden muss, und die hierfür notwendigen Mittel bereit zu stellen.

### Werkzeuge

- Torx-Schlüsselset
- Innensechskantschlüsselset
- 10er Schraubenschlüssel
- Schere
- Bandmaß
- Drehmomentratsche - Ø 10
- Kreuzschraubendreher / Schraubendreher
- Kreissäge Ø 35
- Bohrer - Ø 7
- Stichsäge







### Zugehörige Dokumentation

Montageanweisungen	1002606468
Benutzerleitfaden	1002606470
Diagnose bei ausfällen	1002606471
Ersatzteilliste	1002606469

### Enthaltene Dokumentation

Garantie	220AA10010
----------	------------

### Warnhinweise

-  Der Installateur muss im Bereich Fahrzeug-Klimaanlagen ausreichend geschult sein.
-  **Bergstrom** übernimmt keine Verantwortung für Schäden oder Brüche aufgrund einer nicht ordnungsgemäßen Installation oder Bedienung des Geräts oder den Austausch von Teilen bzw. Umbauten, die ohne die erforderliche schriftliche Genehmigung durchgeführt wurden.
-  Mit Kühlgas R-134a vorgekühltes Gerät. **Kühlgaskreislauf nicht manipulieren.**
-  Siehe **Garantieverfahren** des Produkts in der **Fehlerdiagnose**.
-  Siehe **Benutzerleitfaden** des Geräts für den ordnungsgemäßen Betrieb der Fernbedienung und des Bedienfelds.
-  Die folgenden Unterlagen müssen dem Benutzer nach der Installation ausgehändigt werden: **Benutzerleitfaden, Garantie und Fehlerdiagnose.**

**1** Integral Power II auf einer ebenen Fläche auf dem Dach positionieren. Dabei berücksichtigen, dass die endgültige Position mit der mitgelieferten Front übereinstimmen muss.

**2** Nach Festlegung der Position, das Gehäuse abnehmen und (6) Löcher (Y) markieren. Danach die (4) Bohrlöcher der Vorlage mit (4) hinteren Löchern des Dachs (Abb. 3) in Übereinstimmung bringen.  
**Auf den Pfeil achten, der die Fahrtrichtung anzeigt.**

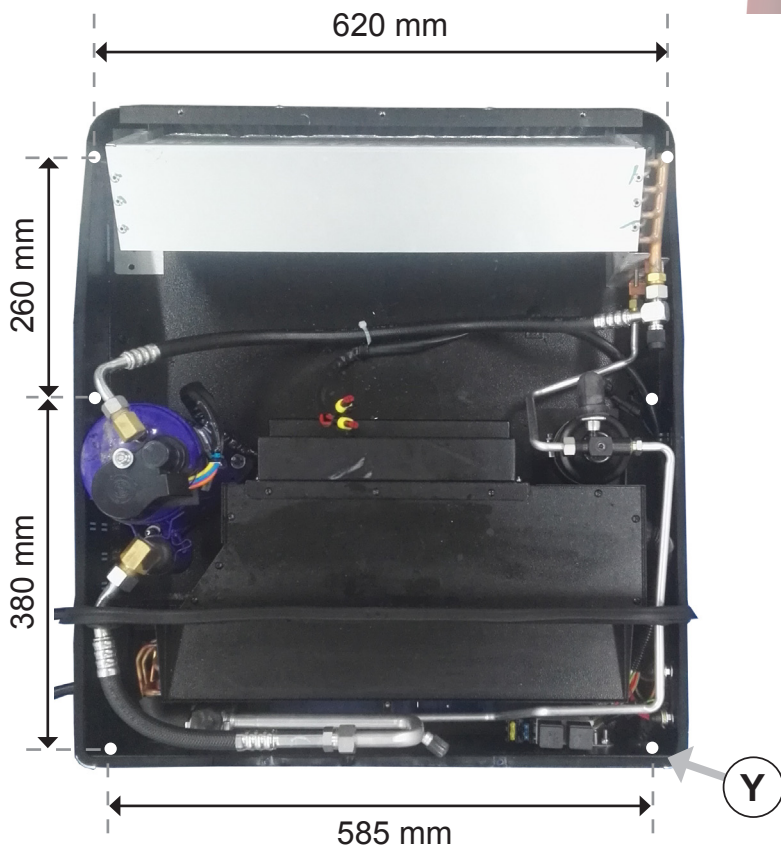
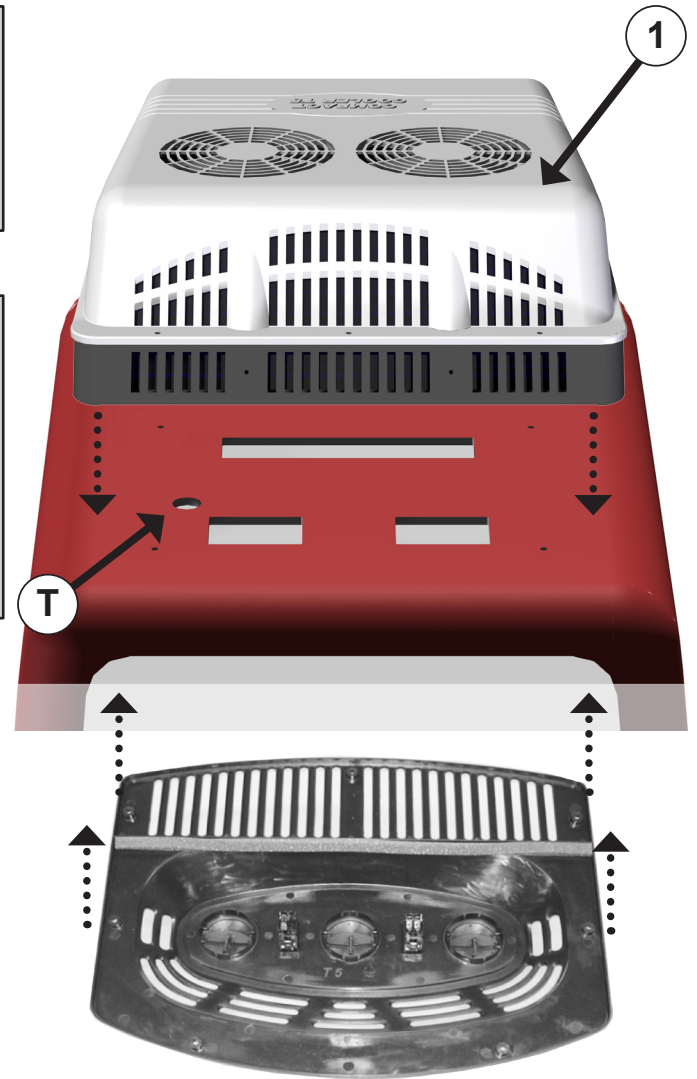

**3** Die Schnitte und Bohrlöcher markieren und durchführen (die Schnittkanten mit Rostschutzmittel schützen).

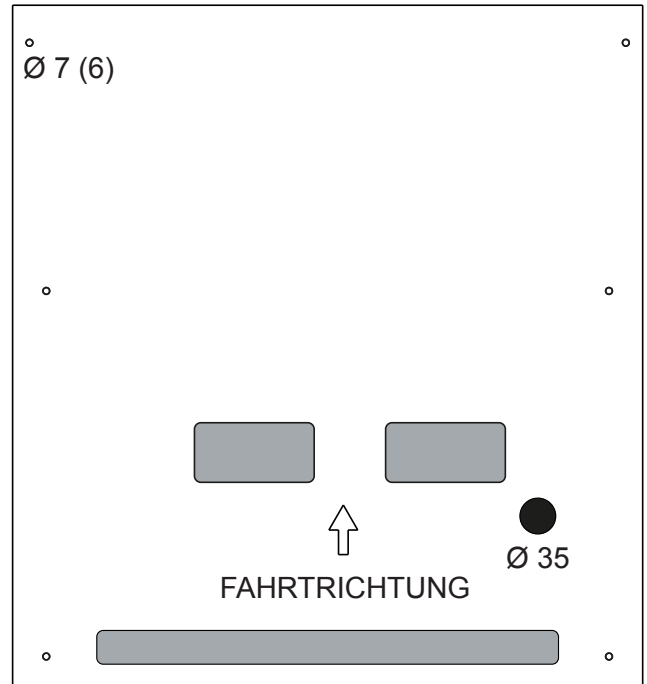

**4** Verschlussdichtung, Seitendichtungen und Frontdichtung auf der Innenseite der Kompaktanlage wie gezeigt anbringen.

<b>a</b>	Verschlussdichtung
<b>b</b>	Seitendichtungen
<b>c</b>	Frontdichtung

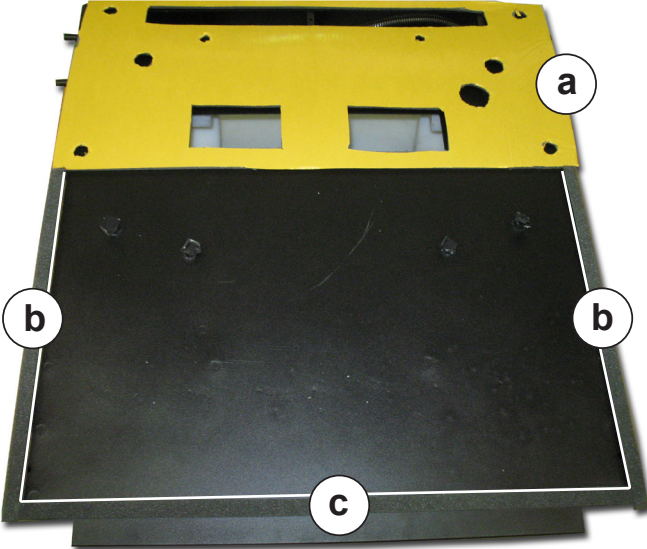

**5** Kabel durch das hierfür angefertigte Bohrloch (T) führen (Abb. 1). **Integral Power** (A) mit (6) 13 mm Hülsen, Gummischeiben und (6) Schrauben M6/100x40 (B) und Muttern M6/100 anbringen.

**Wichtiger Hinweis:** Dichtigkeit der Baugruppe zum Dach hin sicherstellen, um möglichen Wassereintritt zu verhindern.

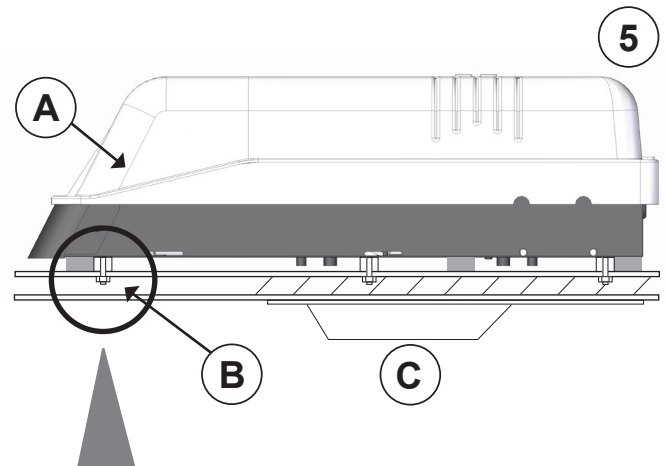

**6A** Gummiunterlegscheiben zur Vermeidung von Wassereintritt anbringen.

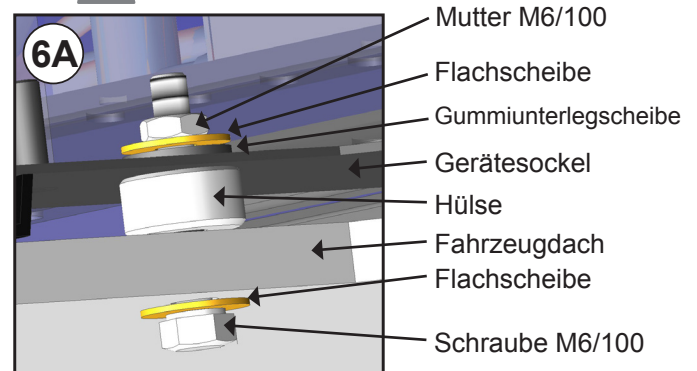

**6B** Mitgelieferte PVC-Schläuche Ø 9 x Ø 13 je nach Längenbedarf verlegen.

 **Achtung:** Drainageventile am Ende der PVC-Schläuche anbringen, damit das Wasser ablaufen kann.

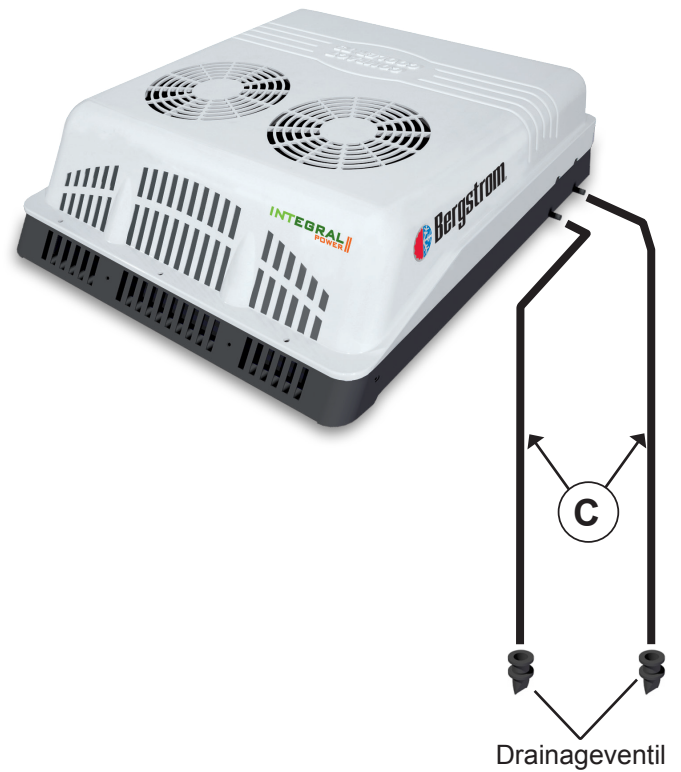

**Alternatoranschlussverkabelung für den Betrieb des Geräts bei laufendem Motor**

 **Achtung:** Die Kabel in allen Fahrzeugen installieren, damit das Gerät bei laufendem Motor funktioniert.

**7** Erregerkabel von innen oder außen her verlegen und Front mit den mitgelieferten Blechschrauben befestigen. Schalter wie gezeigt anschließen.

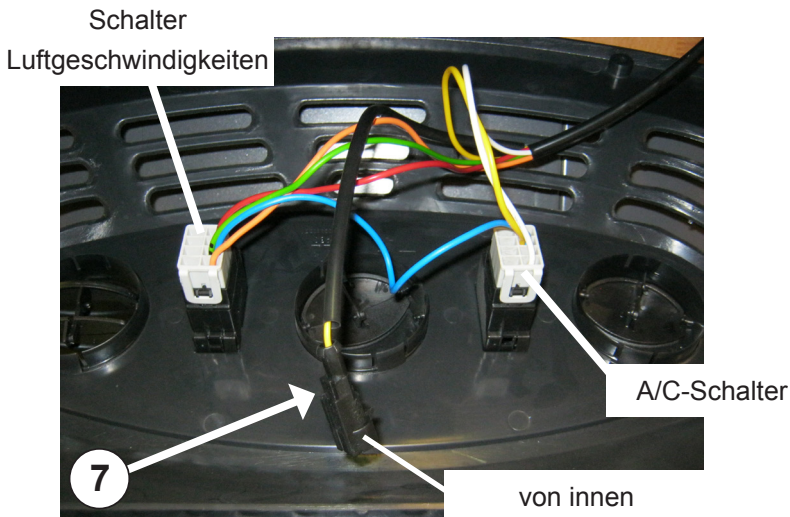
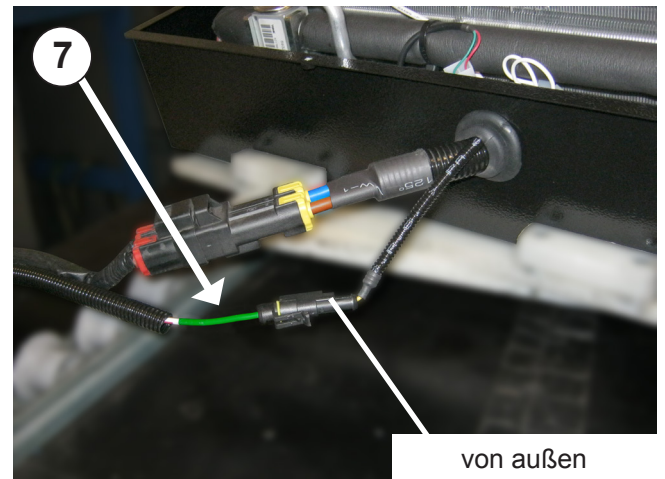

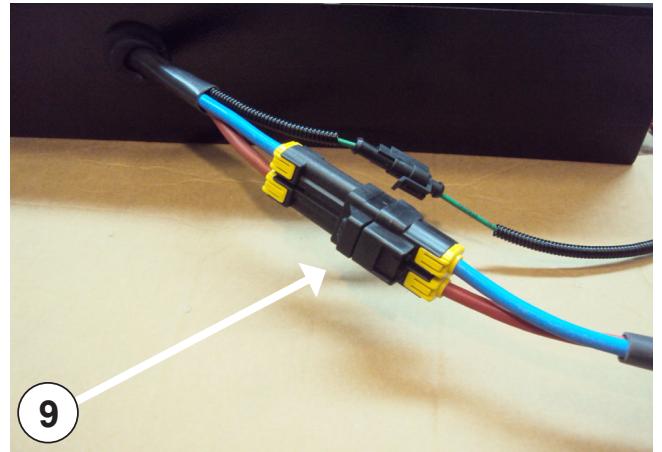

**8** Das andere Ende des mitgelieferten Kabels in Position (+) nur bei laufendem Motor oder über (+) Kontaktschlüssel anschließen.

**9** Oberes Stromkabel an der Hinterseite des Geräts anschließen.

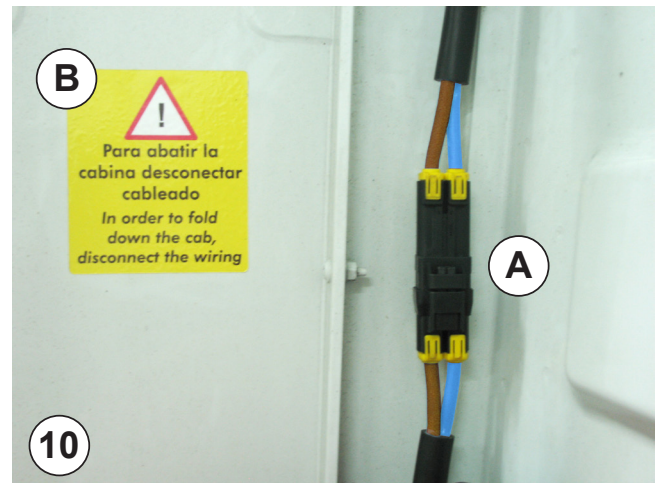

**10** Unteres Stromkabel (A) anschließen und zur Batterie führen und Gefahrenaufkleber für die Kabelverbindung an einem sichtbaren Ort (B) anbringen.



 **Wichtiger Hinweis:** Beim Anschluss der Kabel ausreichenden Abstand lassen, um deren Bruch durch die Bewegungen des Fahrzeugs zu vermeiden.

 **Wichtiger Hinweis:** Für die Inbetriebnahme, lesen Sie bitte im Benutzerhandbuch (1002185994) nach.

Elektrische Verkabelung

AZ	Blau
N	Schwarz
R	Rot
V	Grün
B	Weiss
A	Gelb
Na	Orange
M	Braun

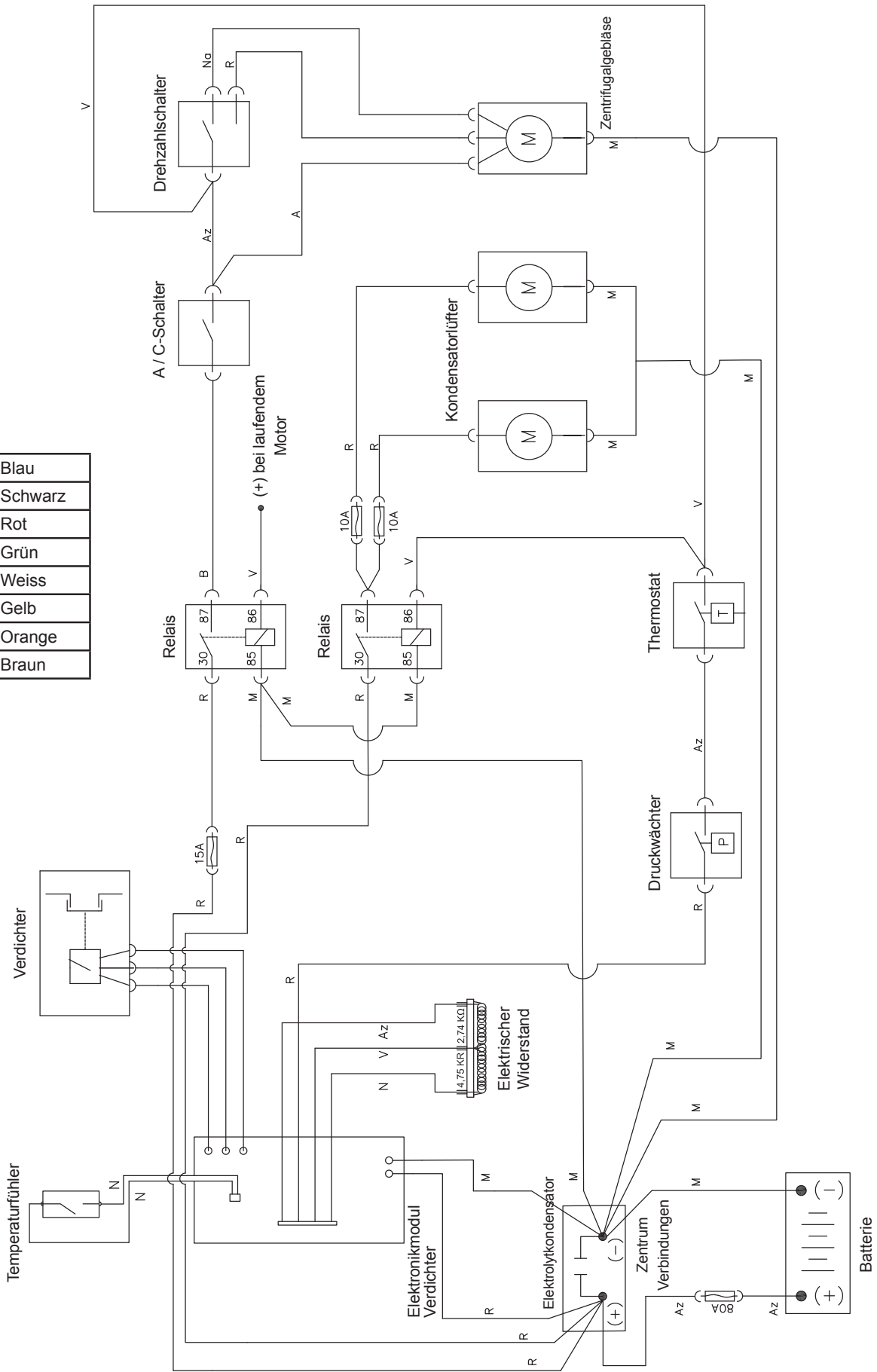



A series of horizontal dotted lines spanning the width of the page, intended for handwritten notes or calculations.

## Suggerimenti Per il montaggio

- Prima di cominciare il montaggio, leggere attentamente le istruzioni e rispettarle nel corso dello stesso.
- Usare gli attrezzi più adatti ad ogni operazione.

## Elettricità

- Scollegare la chiave di contatto.
- Scollegare la batteria prima di cominciare il montaggio.
- Assicurarsi di aver effettuato correttamente l'installazione e il collegamento dei componenti elettrici.

### **Attenzione**

Qualsiasi modifica dei sistemi ROPS / FOPS, come l'esecuzione di saldature o perforazioni nelle parti strutturali, inciderà negativamente sulla capacità di tali sistemi ROPS / FOPS di fornire la protezione richiesta. L'installazione di questo prodotto può incidere sui sistemi ROPS / FOPS.

Rivolgersi al proprio rivenditore di fiducia per verificare la compatibilità prima di effettuare modifiche o riparazioni. Altrimenti si potrebbe essere annullata la certificazione ROPS / FOPS. Il costruttore dell'impianto di aria condizionata montato sul tettuccio declina ogni responsabilità.

### **Attenzione**

Quando si installa l'impianto di aria condizionata sul tettuccio, bisogna proteggere la parte superiore della cabina con uno straccio o una coperta per evitare eventuali graffi. Per l'installazione del **Integral Power II**, tenere presente che normalmente le cabine munite di oblò dispongono di una struttura abbastanza solida per sostenere il peso dell'impianto. Tuttavia, se così non fosse e se fosse necessario tagliare il tettuccio, o se in presenza di oblò la struttura non fosse abbastanza rigida (se fosse di fibra, plastica, ecc.), è responsabilità dell'installatore decidere se occorre rinforzare il tettuccio per evitare qualsiasi deformazione, rottura o penetrazione d'acqua, ecc., prendendo le misure necessarie per evitarlo.

## Attrezzi

Set di chiavi Torx  
Set di chiavi a brugola  
Chiave fissa 10  
Forbici  
Flessometro  
Set chiavi a cricchetto - bocca Ø 10  
Cacciavite stella / cacciavite  
Sega circolare Ø 35  
Trapano - bocca Ø 7  
Sega a svolgere







## Documenti correlati

Istruzioni di montaggio	1002606468
Guida dell'utente	1002606470
Diagnosi dei problemi	1002606471
Elenco ricambi	1002606469

## Documentazione allegata

Garanzia	220AA10010
----------	------------

### **Avvertenze**

-  L'installatore deve essere in possesso della formazione necessaria in materia di aria condizionata per veicoli.
-  **Bergstrom** declina ogni responsabilità per danni o rotture derivanti dall'errata installazione o dall'errato uso dell'impianto o da sostituzioni o modifiche effettuate senza la necessaria autorizzazione per iscritto.
-  Dispositivo precaricato con gas refrigerante R-134a. **Non manomettere il circuito di gas refrigerante.**
-  Vedi la **procedura di garanzia** del prodotto in **Diagnosi dei problemi**.
-  Vedi la **Guida dell'utente** dell'impianto per il corretto funzionamento del telecomando e del pannello di controllo.
-  I seguenti documenti devono essere consegnati all'utente una volta conclusa l'installazione: **Guida dell'utente, Garanzia e Diagnosi dei problemi**.

**1** Posizionare l'impianto **Integral Power II** sul tettuccio, tenendo conto che la posizione finale deve coincidere con il frontalino in dotazione facendo in modo che sia livellato sulla superficie.

**2** Una volta determinata la posizione, rimuovere l'involucro e segnare i (6) fori (Y) e quindi fare coincidere i (4) fori della dima con i (4) fori posteriori del tettuccio (figura 3).  
**Tenere conto della freccia che indica il senso di marcia.**

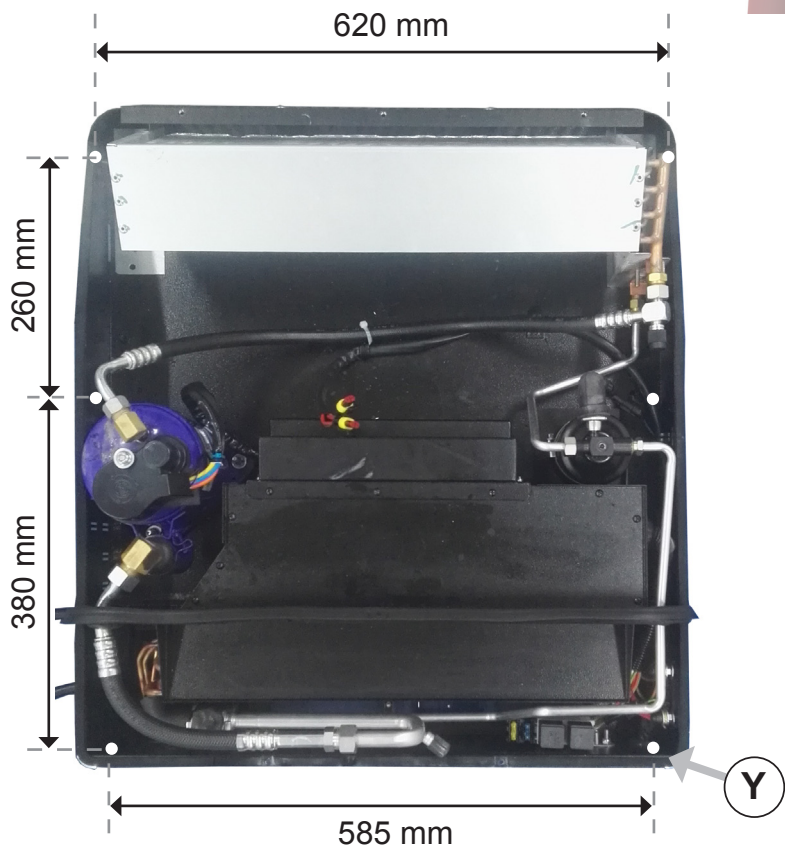
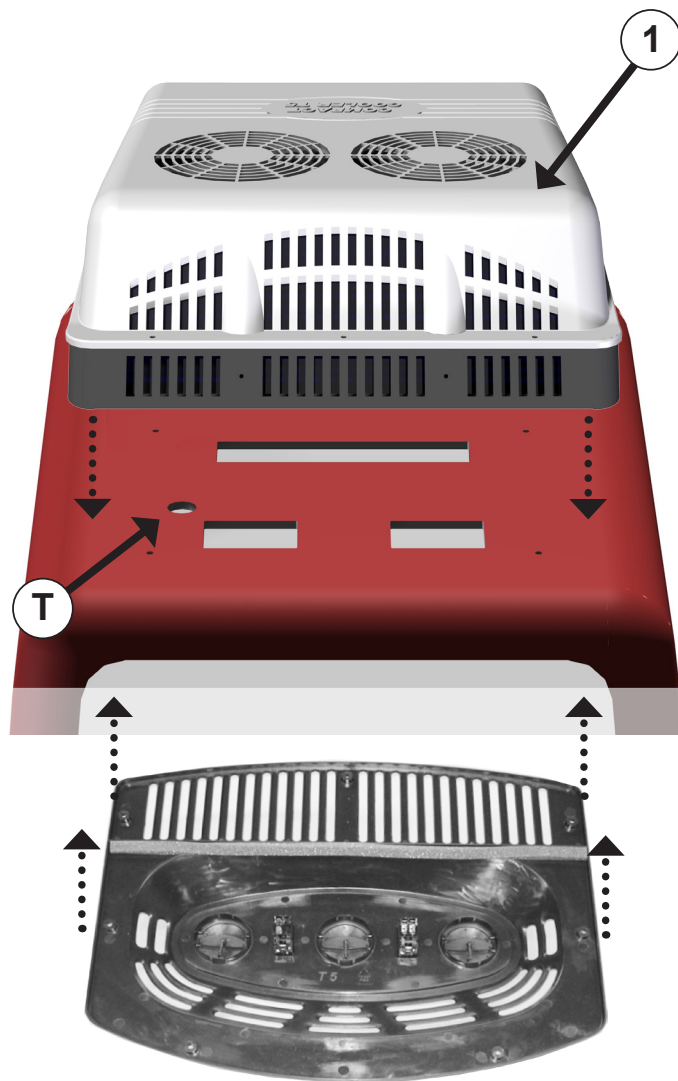

**3** Segnare i tagli e i fori e quindi eseguirli (proteggere i bordi tagliati con antiossidante).

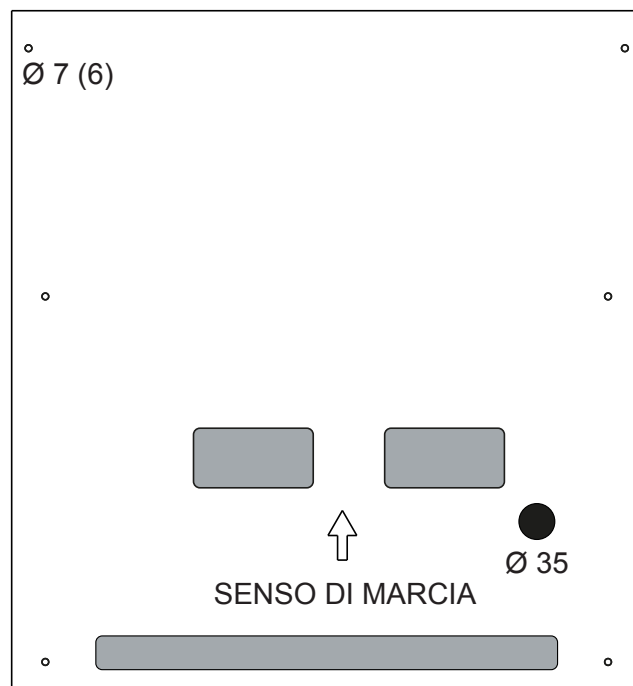

**4** Montare la guarnizione di chiusura, le guarnizioni laterali e quella frontale nella parte interna, come illustrato nella figura.

<b>a</b>	Guarnizione di chiusura
<b>b</b>	Guarnizioni laterali
<b>c</b>	Guarnizione frontale

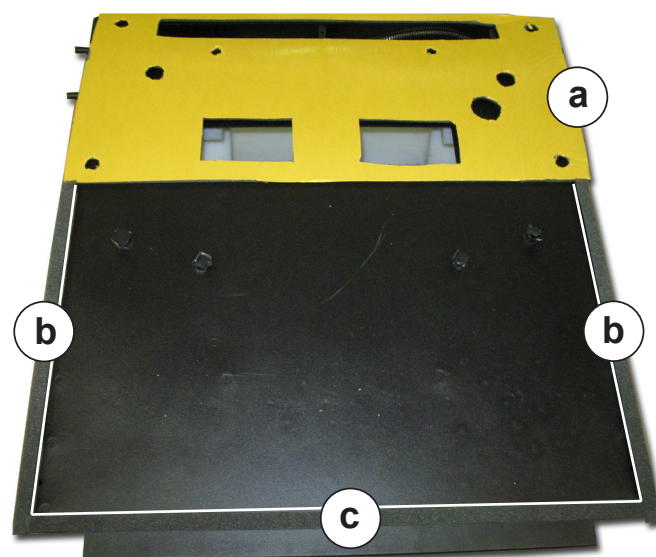

**5** Far passare il cablaggio nell'apposito foro (T) sul tettuccio (figura 1). Fissare l'**Integral Power** (A) con (6) boccole da 13 mm, le rondelle di gomma e (6) viti M6/100x40 (B) e i dadi M6/100.

 **Nota bene:** Verificare la tenuta dell'insieme sul tettuccio per evitare eventuali infiltrazioni d'acqua.

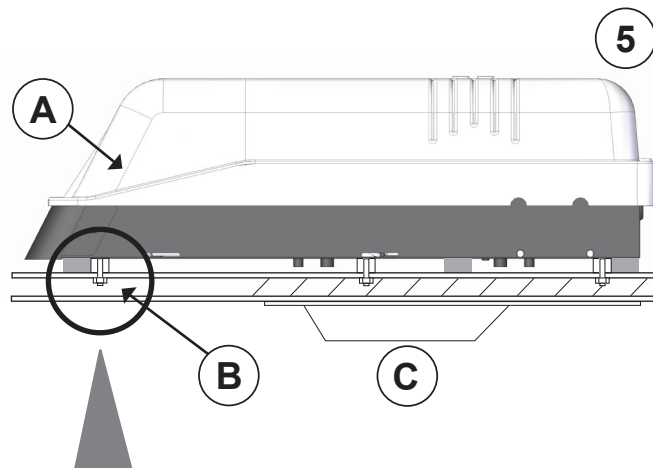

**6A** Inserire le rondelle di gomma per evitare l'infiltrazione dell'acqua.

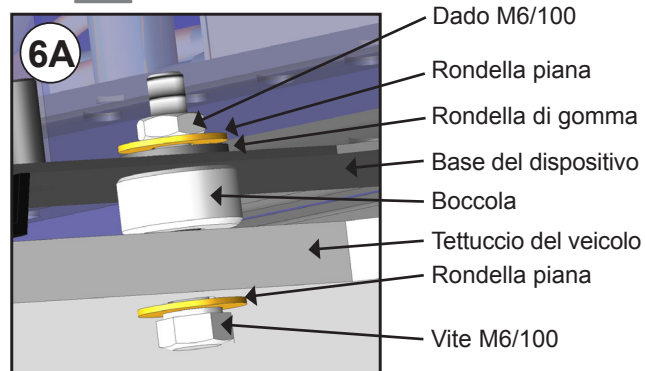

**6B** Montare sull'impianto i tubi in PVC Ø 9 x Ø 13 in dotazione alla lunghezza richiesta.

 **Attenzione:** montare valvole di drenaggio alla fine dei tubi in PVC per agevolare il drenaggio dell'acqua.

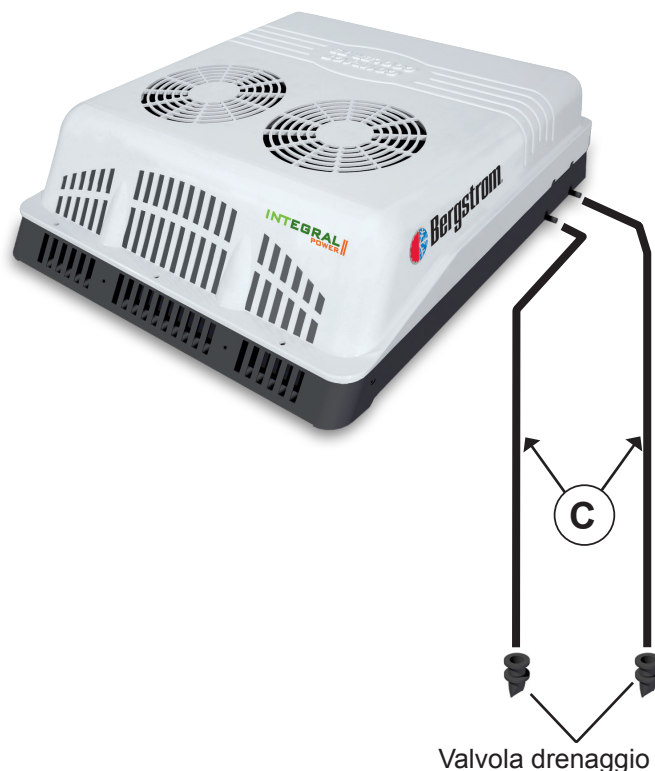

**Cablaggio di connessione all'alternatore per il funzionamento dell'impianto con motore acceso**

 **Attenzione:** Il cablaggio si deve installare in tutti i veicoli in cui l'impianto deve funzionare con il motore acceso.

**7** Far passare il cablaggio d'eccitazione dall'interno o dall'esterno del veicolo a seconda della convenienza e montare il frontalino con le viti per lamiera in dotazione. Collegare gli interruttori come indicato.

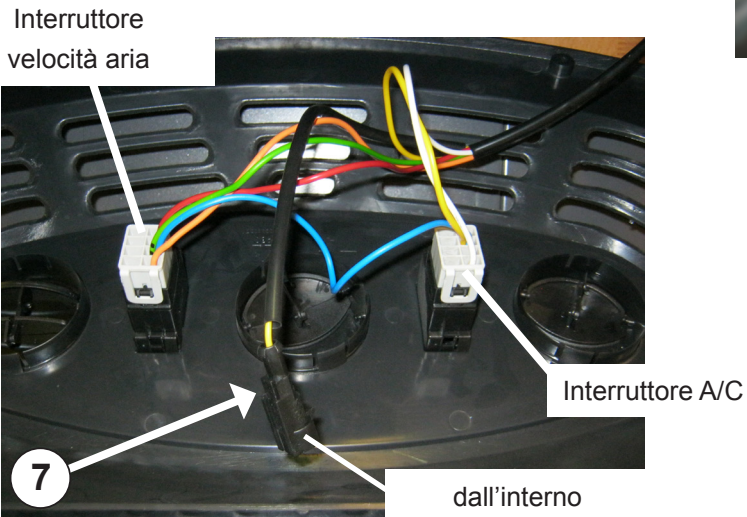
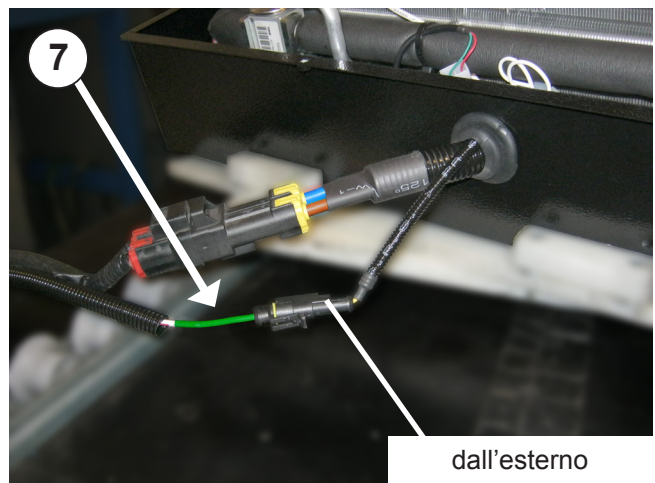

**8** Collegare l'altra estremità del cablaggio in posizione (+) solo (+) con il motore acceso o tramite (+) chiave di accensione.

**9** Collegare il cavo di alimentazione superiore alla parte posteriore dell'impianto.

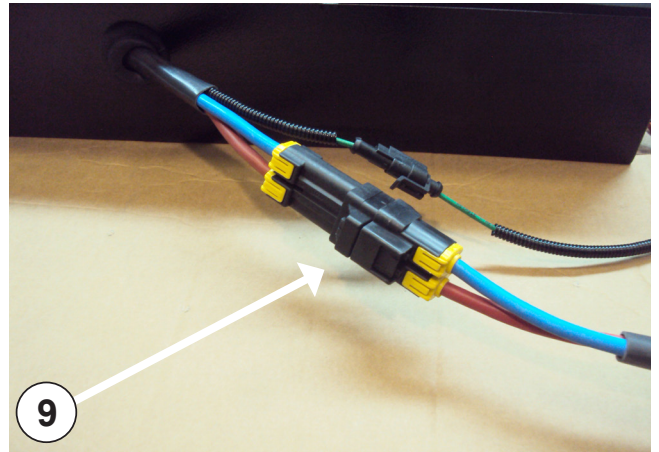

**10** Collegare il cavo di alimentazione inferiore (A) portandolo fino alla batteria e applicare in un posto visibile gli adesivi indicanti il pericolo che comporta la connessione del cablaggio (B).

 **Nota bene:** Per collegare i cablaggi, lasciare una distanza adeguata per evitarne la rottura a causa dei movimenti del veicolo.

 **Nota bene:** Per l'avviamento, vedi il Manuale dell'utente (1002185994).

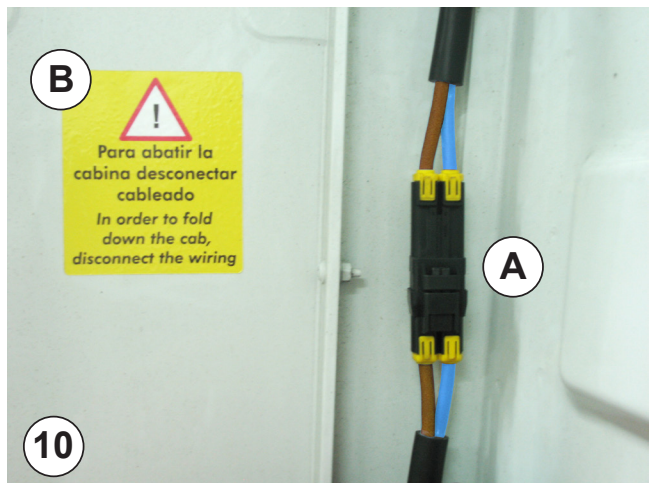

Cablaggio elettrico

Az	Blu
N	Nero
R	Rosso
V	Verde
B	Bianco
A	Giallo
Na	Arancione
M	Marrone

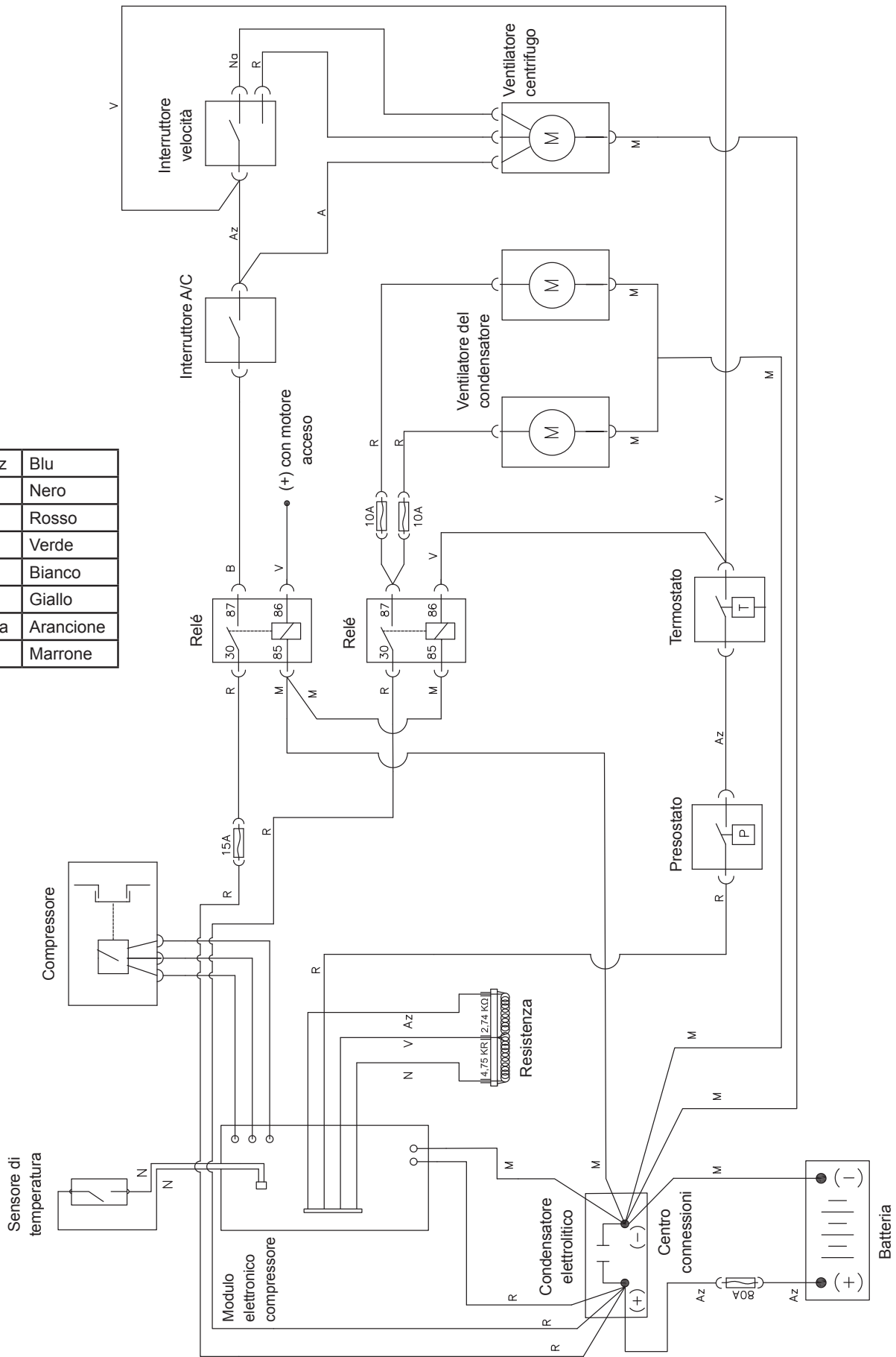



A series of horizontal dotted lines spanning the width of the page, providing a template for writing or drawing.

A series of horizontal dotted lines for writing, spanning the width of the page.

A series of horizontal dotted lines spanning the width of the page, providing a template for writing or drawing.



Francisco Alonso, 6  
28806 Alcalá de Henares, Madrid  
SPAIN

Ed:	14/01/2020
Md:	11/02/2020

a

Contact	Phone	Fax	E-Mail
Sales (Ventas Internacional)	+34 91 8770510	+34 91 8771158	sales@dirna.bergstrominc.com
Comercial Nacional	+34 91 8775841	+34 91 8836321	ventas@dirna.bergstrominc.com
Orders & Deliveries (Logística internacional)	+34 91 8775846	+34 91 8771158	export@dirna.bergstrominc.com
Orders & Deliveries (Logística nacional)	+34 91 8775840	+34 91 8836321	comercial@dirna.bergstrominc.com
Technical Assistance (Internacional)	+49 511 86679681	+49 511 86679710	technicalassistance@dirna.bergstrominc.com
Technical Assistance (Nacional)	+34 91 8775845	+34 91 883 6321	oblanco@dirna.bergstrominc.com

[www.dirna.com](http://www.dirna.com)

	<b>ATENCIÓN:</b>	Bergstrom se reserva el derecho de efectuar modificaciones en cualquier momento de los datos contenidos en esta publicación, por razones técnicas o comerciales.
	<b>NOTE:</b>	<i>For technical and commercial reasons, Bergstrom reserves the right to change the data contained in this brochure.</i>
	<b>ATTENTION:</b>	Bergstrom se réserve le droit d'effectuer à tout moment des modifications des données reprises sur cette publication, pour des raisons techniques ou commerciales.
	<b>HIWEIS:</b>	<i>Bergstrom behält sich vor, aus technischen oder kaufmännischen Gründen jederzeit Änderungen der Angaben dieser Veröffentlichung vorzunehmen.</i>
	<b>ATTENZIONE:</b>	Bergstrom si riserva il diritto di effettuare modifiche in qualsiasi momento ai dati contenuti in questa pubblicazione, per motivi tecnici o commerciali.